

Measuring Range and Output Characteristics

For each sensor a minimum distance to the target (measurement object) must be maintained. This avoids a measurement uncertainty due to the sensor pressing on the target and mechanical damage to the sensor/target. Start of measuring range (SMR) of DT3005-U3-x-C1 is 0.3 mm.

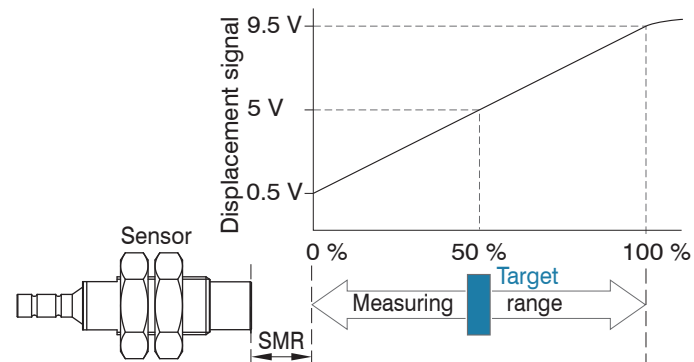

Fig. 1 Start of measuring range (SMR), the smallest distance between sensor face and measuring object

Decommissioning, Disposal

➡ Disconnect the power supply and output cable on the sensor. Incorrect disposal may cause harm to the environment. Dispose of the device, its components and accessories, as well as the packaging materials in compliance with the applicable country-specific waste treatment and disposal regulations of the region of use.

Installation Conditions

The relative size of the measuring object to the sensor has effects on the linearity deviation for eddy current sensors. Ideally, the measuring object size is at least 4 times the sensor diameter.

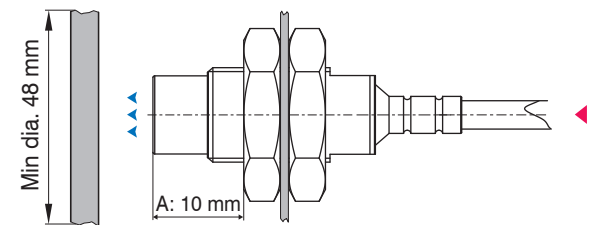

Fig. 2 Assembly, dimensions in mm (not to scale)

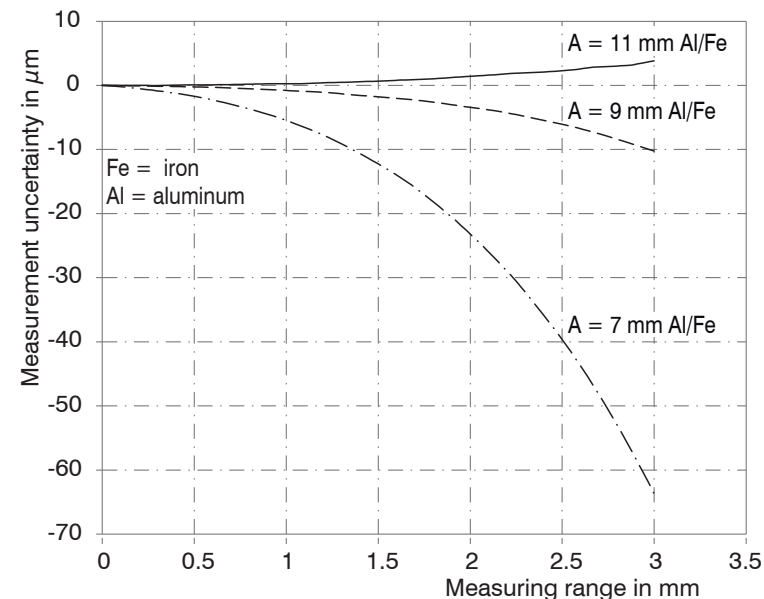

Fig. 3 Measurement uncertainty depending on distance A and target material

Liability for Material Defects

All components of the device have been checked and tested for functionality at the factory. However, if defects occur despite our careful quality control, MICRO-EPSILON or your dealer must be notified immediately.

The liability for material defects is 12 months from delivery. Within this period, defective parts, except for wearing parts, will be repaired or replaced free of charge, if the device is returned to MICRO-EPSILON with shipping costs prepaid. Any damage that is caused by improper handling, the use of force or by repairs or modifications by third parties is not covered by the liability for material defects. Repairs are carried out exclusively by MICRO-EPSILON.

Further claims can not be made. Claims arising from the purchase contract remain unaffected. In particular, MICRO-EPSILON shall not be liable for any consequential, special, indirect or incidental damage. In the interest of further development, MICRO-EPSILON reserves the right to make design changes without notification.

For translations into other languages, the German version shall prevail.

Optional Accessories

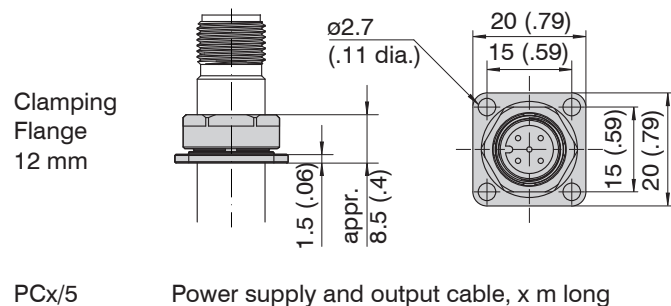

PCx/5

Power supply and output cable, x m long

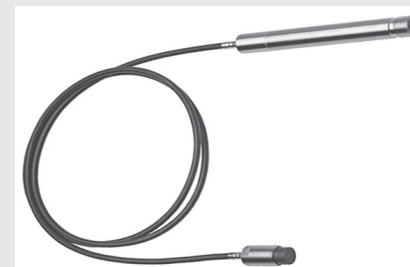

Safety

System operation assumes knowledge of the assembly instructions. The following symbols are used in these assembly instructions:

CAUTION Indicates a hazardous situation which, if not avoided, may result in minor or moderate injury.

NOTICE Indicates a situation that may result in property damage if not avoided.

▶ Indicates a user action.

i Indicates a tip for users.

Warnings

CAUTION

Connect the power supply and the display/output device according to the safety regulations for electrical equipment.

- > Risk of injury by electric shock
- > Damage to or destruction of the sensor

NOTICE

The supply voltage may not exceed the specified limits.

- > Damage to or destruction of the sensor
- Avoid shocks and impacts to the sensor.

> Damage to or destruction of the sensor

Protect the cable against damage.

> Failure of the measuring device

Intended Use

The eddyNCDT 3005 is designed for use in industrial and laboratory applications. It is used for displacement, distance, thickness and movement measurement and for position measuring of parts or machine components. The system must only be operated within the limits specified in the technical data. The system must be used in such a way that no persons are endangered or machines and other material goods are damaged in the event of malfunction or total failure of the system. Take additional precautions for safety and damage prevention in case of safety-related applications.

Technical Data

Sensor	DT3005-U3-x-C1
Measuring range	3 mm
Start of measuring range (SMR)	0.3 mm
End of measuring range (EMR)	3.3 mm
Output	0.5 ... 9.5 V
Power supply	12 ... 32 VDC, appr. 0.6 W
Warm-up time	5 minutes
Protection class	IP 67 (connected)
Pressure resistance sensor	10 bar
Operating temperature sensor and cable controller	-30 ... 125 °C
	-20 ... 70 °C
Storage temperature	-20 ... 80 °C
Humidity	5 ... 95 % (non-condensing)
Sensor cable outer diameter	3.6 mm ± 0.2 mm
Visible sensor cable length	1 m
Minimum bending radius sensor cable	20 mm, static 40 mm, dynamic

Pin Assignment

DT3005-x	PCx/5	Color
1	+ 24 V supply	brown
2	Displacement signal	white
3	GND	blue
4	Assigned internally	black
5		grey

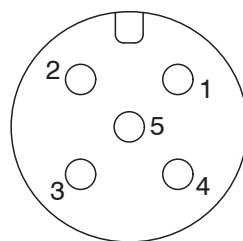

Installation and Assembly

No sharp or heavy objects should be allowed to affect the cable sheath or the sensor cable, the supply cable and the output cable.

▶ Check all plug-in connections for firm seating before starting operation.

Construction: The front part of the sensor with encapsulated coil consists of electrically non-conducting materials.

i In the radial direction metal parts in the vicinity may behave similar to the measuring object, rendering the measurement result inaccurate. Please note this by selection of material for sensor mounting and their setup.

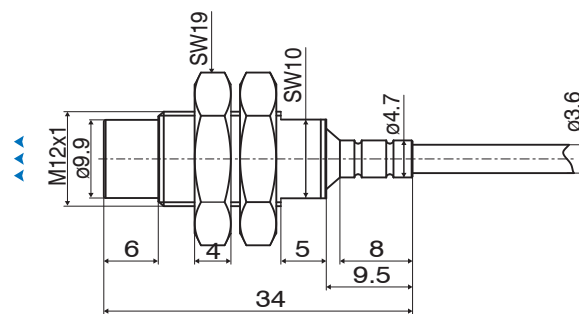

Fig. 5 ES-U3-C-CAx, dimensions in mm (not to scale)

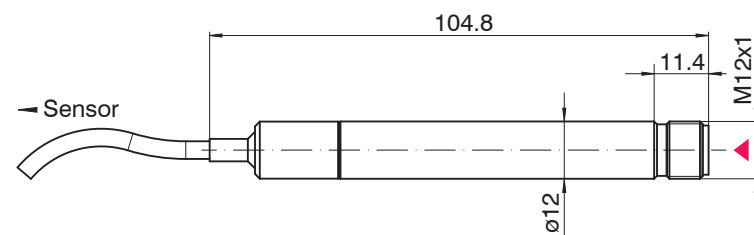

Fig. 6 DT3005-x, dimensions in mm (not to scale)

▲▲▲ Measuring direction

▲ Male connector side

Measurement Setup

Sensors of the eddyNCDT 3005 series cannot be synchronized. Observe a few simple mounting conditions for two nearby mounted sensors.

