



More Precision

capa**NCDT** // Capacitive displacement sensors and systems





- Modular, expandable for up to 4 channels
- Ethernet / EtherCAT interface
- Easy configuration using the web browser
- Resolution up to 0.0005% FSO
- Bandwidth: up to 20kHz
- Digital data rate: 4 x 3.9kSa/s
- Trigger feature
- Synchronous operation supported

System design

The new capaNCDT 6200 is a modular measuring system that offers excellent performance at a very attractive price. A modular design enables the system to be expanded at any time by up to four measuring channels. The measuring system includes a control unit and a demodulator for each sensor. The Ethernet interface integrated in the controller enables fast, easy configuration via web browser. The DL6230 demodulator provides high resolution measurements. capaNCDT 6222 is used for high speed measurements up to 20kHz.

The compact controller can be used as a benchtop unit, wall-mounted unit or DIN rail-mount via an adapter. The capaNCDT 6200 is compatible with all sensor models from Micro-Epsik



Web interface

The web interface for controller configuration opens via Ethernet. Up to 8 channels can be visualized and linked arithmetically.

A measuring system consists of:

- Control unit DT62xx
- Demodulator DL62xx
- Sensor
- Sensor cable
- Power supply cable
- Ethernet cable EtherCAT cable
- Signal output cable

Accessories:

- Signal output cable
- Power supply cable
- DIN rail brackets
- mounting plates for wall mounting

Block diagram

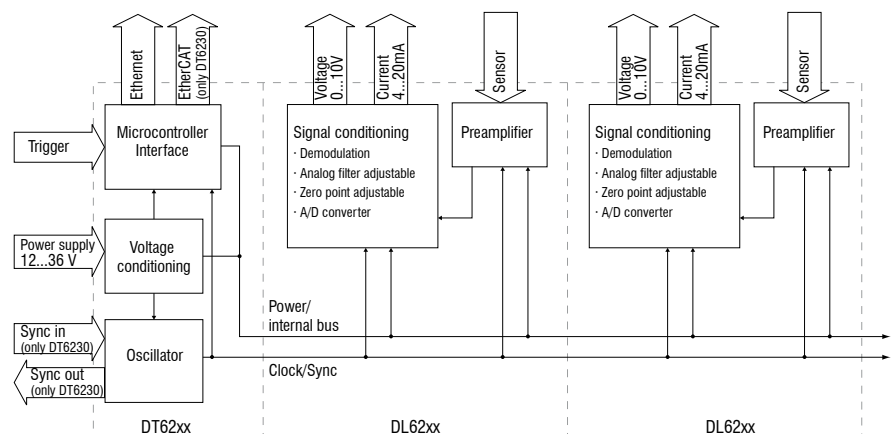

Controller type DT62x0		Demodulator DL6220	Demodulator DL6230
Resolution static		0.004% FSO	0.0005% FSO
Resolution dynamic		0.02% FSO (5kHz)	0.005% FSO (5kHz)
Bandwidth		5kHz (-3dB)	5kHz (-3dB)
Bandwidth (switchable)		5kHz, 20Hz	5kHz, 20Hz
Data rate digital output		max. 3.906kSa/s	max. 3.906kSa/s
Linearity (typ.)		≤ 0.05% FSO	≤ 0.025% FSO
Sensitivity deviation		≤ 0.1% FSO	≤ 0.1% FSO
Long-term stability		≤ 0.02% FSO/month	≤ 0.02% FSO/month
Synchronous operation supported	DT6220	yes (only internal)	yes (only internal)
	DT6230	yes	yes
Insulator measurement		no	no
Temperature stability		200ppm	200ppm
Temperature range (during operation)	Sensor	-50 ... + 200°C	-50 ... + 200°C
	Controller	+10 ... +60°C	+10 ... +60°C
Temperature range (storage)		-10 ... +75°C	-10 ... +75°C
Supply	DT6220	24VDC (12 ... 36 VDC)	24VDC (15 ... 36VDC)
	DT6230	24VDC (15 ... 36 VDC)	24VDC (15 ... 36VDC)
Power consumption	per DL62x0	1.8W (typ.); 2.0W (max.)	1.9W (typ.); 2.2W (max.)
	DT6220	3.1W (typ.)	3.1W (typ.)
	DT6230	3.8W (typ.)	3.8W (typ.)
Analog output		0 ... 10V (short circuit proof)	0 ... 10V (short circuit proof)
		4 ... 20mA (load max. 500Ohm)	4 ... 20mA (load max. 500Ohm)
Digital interface	DT6220	Ethernet	Ethernet
	DT6230	Ethernet + EtherCAT	Ethernet + EtherCAT
Sensors		suitable for all sensors	suitable for all sensors
Sensor cable standard		CC cable ≤ 1m CCm cable = 1.4m CCg cable = 2m	CC cable ≤ 1m CCm cable = 1.4m CCg cable = 2m
Sensor cable (special tuning)		double / triple standard cable length	double / triple standard cable length
Trigger		TTL, 5V	TTL, 5V
No. of channels		max. 4	max. 4

FSO = Full Scale Output

Controller type DT6222	Demodulator DL6222	Demodulator DL6222/ECL2
Resolution static	0.004% FSO	0.004% FSO
Resolution dynamic	0.05% FSO (20kHz)	0.1% FSO (20kHz)
Bandwidth	20kHz (-3dB)	20kHz (-3dB)
Bandwidth (switchable)	20kHz, 20Hz	20kHz, 20Hz
Data rate digital output	max. 3.906kSa/s	max. 3.906kSa/s
Linearity (typ.)	≤ 0.1% FSO	≤ 0.2% FSO
Sensitivity deviation	≤ 0.1% FSO	≤ 0.1% FSO
Long-term stability	≤ 0.02% FSO/month	≤ 0.02% FSO/month
Synchronous operation supported (multiple controllers)	no	no
Insulator measurement	no	no
Temperature stability	200ppm	200ppm
Temperature range (during operation)	Sensor -20 ... +200°C Controller +10 ... +60°C	-20 ... +200°C +10 ... +60°C
Temperature range (storage)	-10 ... +75°C	-10 ... +75°C
Supply	24VDC (12 ... 36 VDC)	24VDC (12 ... 36 VDC)
Power consumption	DT6222 2.8W (typ.) per DL6222 1.2W (typ.); 1.4W (max.)	2.8W (typ.) 1.2W (typ.); 1.4W (max.)
Analog output	0 ... 10V (short circuit proof) 4 ... 20mA (load max. 500Ω)	0 ... 10V (short circuit proof) 4 ... 20mA (load max. 500Ω)
Digital interface	Ethernet	Ethernet
Sensors	suitable for all sensors	suitable for all sensors
Sensor cable standard	CCm1,4x; CCg2,0x	CCm2,8x; CCg4,0x
Sensor cable (special tuning)	≤ 2.8m (with CCmxx) ≤ 4.0m (with CCgxx)	≤ 2.8m (with CCmxx) ≤ 4.0m (with CCgxx)
Trigger	TTL, 5V	TTL, 5V
No. of channels	max. 4	max. 4

FSO = Full Scale Output

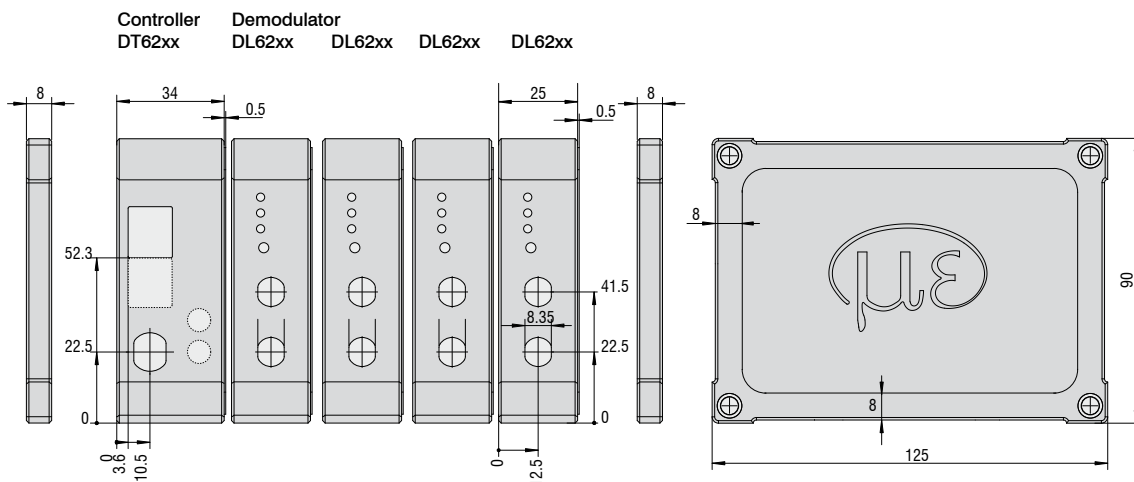

Options						
Art. No.	Description	Description	Suitable for articles			
			2303018 DL6220	2303022 DL6220/ECL2	2303023 DL6220/ECL3	2303029 DL6220/LC
2982044	LC DL62x0 digital	special calibration of linearity on digital output	○	○	○	•
2982045	LC DL62x0 analog	special calibration of linearity on analog output	○	○	○	•
2982046	ECL2 DL6220	special tuning for double standard cable length (CC = 2m / CCm = 2.8m / CCg = 4m)	-	•	-	•
2982047	ECL3 DL6220	special tuning for triple standard cable length (CC = 3 m / CCm = 4,2 m / CCg = 6 m)	-	-	•	•
2982048	EMR2 DL6220	extended measuring range (factor: 2) contains LC DL62x0 digital and LC DL62x0 analog	○	○	○	•
2982049	RMR1/2 DL6220	reduced measuring range (factor: 1/2) contains LC DL62x0 digital and LC DL62x0 analog	○	○	○	•

Art. No.	Description	Description	Suitable for articles			
			2303019 DL6230	2303024 DL6230/ECL2	2303025 DL6230/ECL3	2303030 DL6230/LC
2982044	LC DL62x0 digital	special calibration of linearity on digital output	○	○	○	•
2982045	LC DL62x0 analog	special calibration of linearity on analog output	○	○	○	•
2982054	ECL2 DL6230	special tuning for double standard cable length (CC = 2m / CCm = 2.8m / CCg = 4m)	-	•	-	•
2982055	ECL3 DL6230	special tuning for triple standard cable length (CC = 3m / CCm = 4.2m / CCg = 6m)	-	-	•	•
2982051	EMR2 DL6230	extended measuring range (factor: 2) contains LC DL62x0 digital and LC DL62x0 analog	○	○	○	•
2982052	EMR3 DL6230	extended measuring range (factor: 3) contains LC DL62x0 digital and LC DL62x0 analog	○	○	○	•
2982053	RMR1/2 DL6230	reduced measuring range (factor: 1/2) contains LC DL62x0 digital and LC DL62x0 analog	○	○	○	•

Art. No.	Description	Description	Suitable for articles		
			2303035 DL6222	2303036 DL6222/ECL2	2303038 DL6222/LC
2982045	LC DL62x0 analog	special calibration of linearity on analog output	○	○	•
2982059	ECL2 DL6222	special tuning for double standard cable length	-	•	•
2982061	EMR2 DL6222	extended measuring range (factor: 2)	○	○	•
2982062	RMR1/2 DL6220	reduced measuring range (factor: 1/2)	○	○	•

- Articles already contain the option
- Option available
- No option available

Sensor cable	Cable CCx,x / CCx,x/90	Cable CCmx,x / CCmx,x/90	Cable CCgx,x / CCgx,x/90
Description	Low-outgassing cable up to 4m length, for applications in clean rooms	Low-outgassing cable up to 4.2m length, for applications in clean rooms, UHV and EUV	Robust cable up to 8m length, for industrial applications
Temperature stability	-100°C to +200°C	-100°C to +200°C	-20°C to +80°C (permanent) -20°C to +100°C (10,000 h)
Outer diameter	3.1mm ±0.1mm	2.1mm ±0.1mm	3.1mm ±0.1mm
Bending radius	3x cable diameter during installation; 7x cable diameter for movement; 12x cable diameter recommend at continuous movement		

Design	Cable with connector type C for sensors CS005 / CS02 / CS05 / CSE05 / CS08 / CSE1						Cable with connector type B for sensors CS1 / CS1HP / CS2 / CSE2 / CS3 / CS5 / CS10					
	2 x straight connector			1 x straight / 1 x 90° connector			2 x straight connector			1 x straight / 1 x 90° connector		
Model	CCx,xC	CCmx,xC	CCgx,xC	CCx,xC/90	CCmx,xC/90	CCgx,xC/90	CCx,xB	CCmx,xB	CCgx,xB	CCx,xB/90	CCmx,xB/90	CCgx,xB/90
Standard 1m	•		•	•		•	•		•	•		•
1.4 m		•			•			•			•	
2 m	•		•	•		•	•		•	•		•
2.8 m		•			•			•			•	
3 m	•			•			•			•		
4 m			•			•			•			•
4.2 m		•			•			•			•	
6 m			•			•			•			•
8 m			•			•			•			•

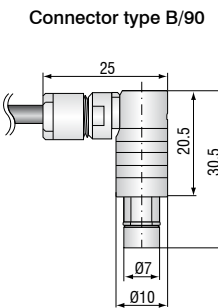
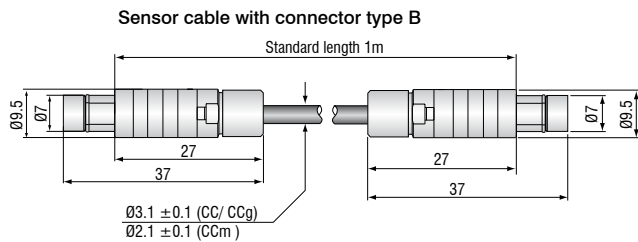
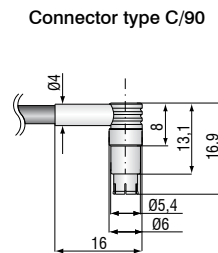
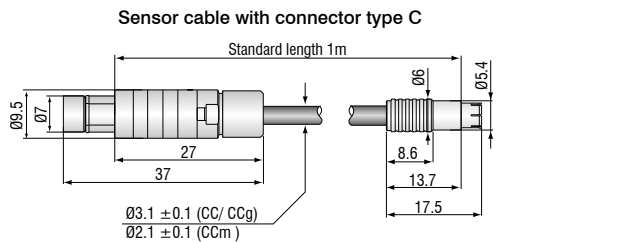

Accessories	capaNCDT	6110	6200	6500
MC2.5 Micrometer for sensor calibration, range 0 - 2.5mm, Resolution 0.1µm. Suitable for sensors CS005 to CS2		•	•	•
MC25D Digital micrometer for sensor calibration, range 0 - 25mm, adjustable offset (zero). Suitable for all sensors.		•	•	•
HV/B Vacuum feed through triaxial		•	•	•
UHV/B Vacuum feed through triaxial for ultra-high vacuum		•	•	•
PC6200-3/4 Power-/trigger cable, 4 pin, 3m			•	
SCAC3/4 Signal output cable, (necessary for multi-channel applications), 4 pin, 3m			•	
SCAC3/5 Signal output cable, analog, 5 pin, 3m		•		
SC6000-1,0 Synchronization cable, 5 pin, 1m			•	•
CA5 Preamplifier cable 5 pin, 5m				•
PS2020 Power supply for DIN rail mounting; Input 230VAC (115VAC); Output 24VDC / 2.5 A; L/W/H 120x120x40mm		•	•	

HV/B Vacuum feed through (Art.-no. 0323050)

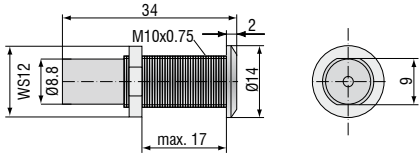

Max. leak rate 1×10^{-7} mbar · l s⁻¹, compatible with connector type B

UHV/B Vacuum feed triax weldable (Art.-no. 0323346)

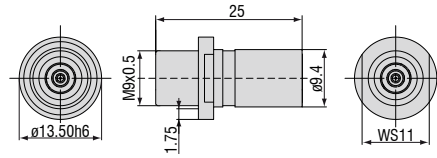

Max. leak rate 1×10^{-9} mbar · l s⁻¹, compatible with connector type B

UHV/B Vacuum feed triax with flange CF16 (Art.-no. 0323349)

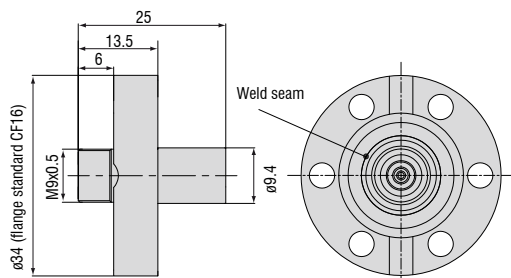

Max. leak rate 1×10^{-9} mbar · l s⁻¹, compatible with connector type B

UHV/B Vacuum feed triax screwable (Art.-no. 0323370)

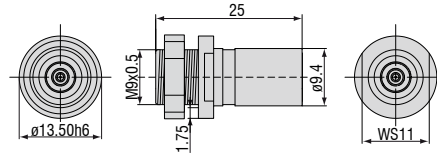

Max. leak rate 1×10^{-9} mbar · l s⁻¹, compatible with connector type B

SCA3/4 Signal output cable (Art.-no. 2902104)

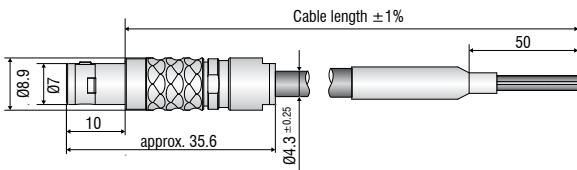

SCA3/5 Signal output cable (Art.-no. 2902112)

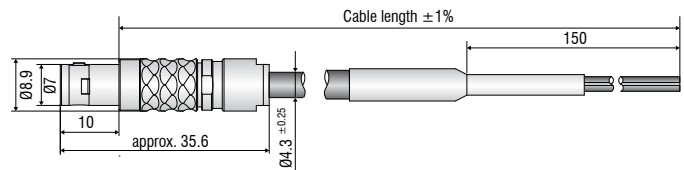

PC6200-3/4 Power-/trigger cable (Art.-no. 2901881)

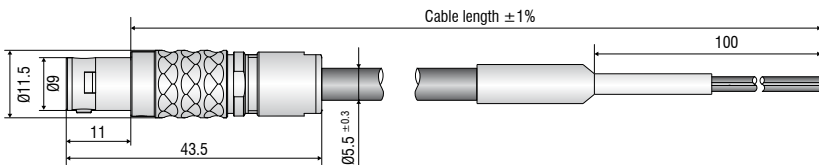

SC6000-1,0 Synchronization cable (Art.-no. 2903473)

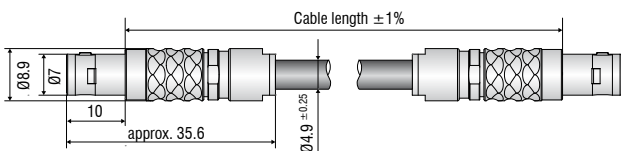

CA5 Preamplifier cable (Art.-no. 2903180)

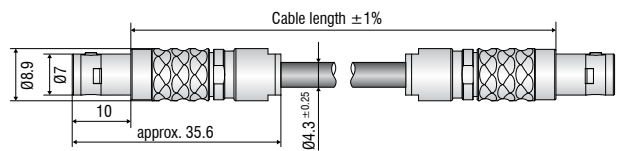

High performance sensors made by Micro-Epsilon



Sensors and systems for displacement and position



Sensors and measurement devices for non-contact temperature measurement



2D/3D profile sensors (laser scanner)



Optical micrometers, fibre optic sensors and fibre optics



Color recognition sensors, LED analyzers and color inline spectrometer



Measurement and inspection systems