



# More Precision

capa**NCDT** // Capacitive displacement sensors and systems





- One-sided thickness measurement in one axis
- Integrated temperature measurement
- Special plug for fast sensor connection
- Thickness measurement based on  $\epsilon_r$
- Determination of  $\epsilon_r$  with known thickness
- Ease of use via web interface

In its sensor housing, the combiSENSOR combines an eddy current displacement sensor and a capacitive displacement sensor. This unique sensor concept enables one-sided thickness measurement of electrically non-conductive materials on metallic objects. Its field of application is the absolute thickness measurement of plastic film or of plastic coating on metal plates. Connected to the sensor via a cable, the controller processes and calculates the signals in order to put them out via interfaces.

Calculation of the two sensor signals provides compensation of mechanical changes such as thermal expansion, deflections or eccentricity in the measurement device. Due to the redundancy of this combined sensor principle, the measured thickness value remains unaffected by any changes in the measurement setup. Due to the high temperature stability, the combiSENSOR provides high measurement accuracy even with fluctuating temperatures.

#### Fields of application

- Non-contact thickness measurement of plastic films
- Non-contact thickness measurement of coated metals
- Measurement of the applied adhesive
- Lateral profile due to a traversing axis

#### Measuring principle

The construction of the eddy current measurement coil and the capacitive measurement electrodes is concentric. Both sensors measure against the same spot. The signal of the capacitive displacement sensor is a function of the working distance, the thickness of the insulator ( $D$ ) and the dielectric constant of the insulator material ( $\epsilon_r$ ). At the same time the eddy current displacement sensor measures the distance to the ground electrode (e.g. metal sheet or metal roller positioned behind the film). The controller outputs both single signals as well as the difference between capacitive sensor and eddy current sensor. Also the dielectric constant can be calculated with known thickness and working distance.

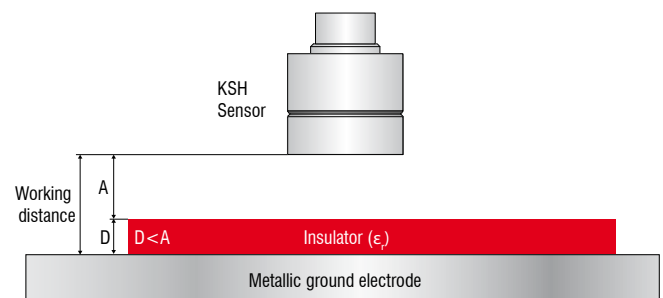

#### Thickness measurement:

If the dielectric constant  $\epsilon_r$  and the working distance from the ground electrode are known, the controller calculates the insulator thickness  $D$  from the sensor signals.

#### Calculation of the dielectric constant:

If the thickness of the Insulator  $D$  and the working distance from the ground electrode are known, the controller calculates the dielectric constant of the insulator.



#### Web interface

The web interface for sensor and controller configuration opens via Ethernet.

Controller		KSS6420	KSS6430	KSS6420(01)	KSS6430(01)
Sensor		KSH5(01)		KSH10	
Target thickness (insulator thickness) <sup>1)</sup>		40 $\mu$ m ... 3 mm		40 $\mu$ m ... 6 mm	
Working distance		2 mm ... 5 mm		4 mm ... 10 mm	
Min. diameter measurement surface		45 mm		65 mm	
Resolution <sup>2)</sup>	static, 100 Hz	0.0018 % FSO	0.0004 % FSO	0.0030 % FSO	0.0006 % FSO
	dynamic, 3.9 kHz	0.0075 % FSO	0.0015 % FSO	0.0120 % FSO	0.0025 % FSO
Bandwidth		analog: 1 kHz (3 dB) <sup>3)</sup> , digital: 2.6 ... 3900 Sa/s (adjustable)			
Linearity		$\leq \pm 0.05$ % FSO			
Temperature stability	Sensor (+10 ... +50 °C)	$\pm 50$ ppm			
	Controller (+10 ... +50 °C)	$\pm 50$ ppm	$\pm 50$ ppm	$\pm 50$ ppm	$\pm 70$ ppm
Temperature range	Operation	controller: +10 ... +60 °C; sensor: -10 ... +85 °C; sensor cable: -10 ... +125 °C			
	Storage	sensor, cable: -10 ... +100 °C; controller: 0 ... +75 °C			
Supply		12 ... 36 VDC (5.5 W)			
Output	Analog	capacitive, eddy current and differential signal: 0 ... 10 V (short circuit proof); internal sensor temperature signal (not scaled)			
	Ethernet	capacitive, eddy current, differential and internal temperature signal: 24 Bit			
	EtherCAT	capacitive, eddy current, differential and internal temperature signal: float			
Trigger		TTL, 5 V			
Target geometry		straight surface or min. diameter 200 mm <sup>4)</sup>			
Protection class		sensor: IP54, controller: IP40			
Weight		sensor: 80 g; controller: 750 g			

FSO = Full Scale Output

<sup>1)</sup> Insulator thickness below 40  $\mu$ m on request

<sup>2)</sup> Difference signal of the digital output, measured with working distance = 50 % FSO

<sup>3)</sup> only valid when sampling rate = 3900 Sa/s

<sup>4)</sup> Reference material ground electrode: VA steel (1.4571) or aluminum. Changes of the ground electrode (material or geometry) require a recalibration of sensor and controller by the manufacturer.

#### Controller

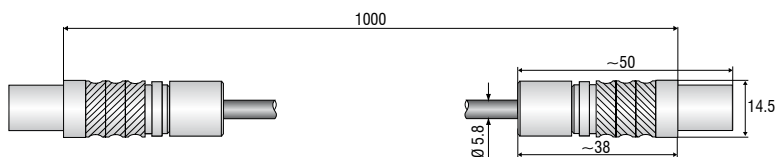
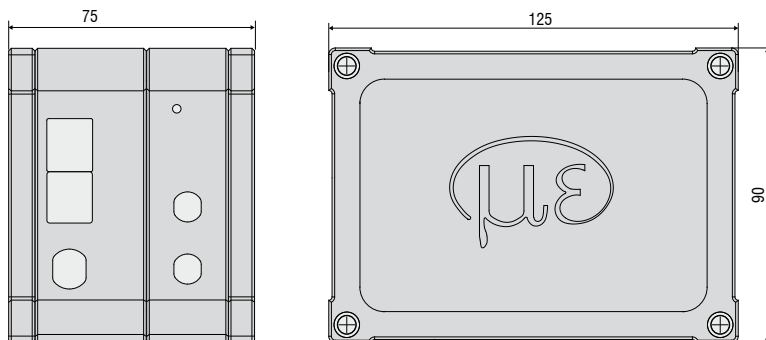

#### SCAC3/5 connector

Signal output (5-pole plug)

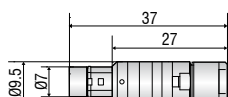

#### KSH5 sensor

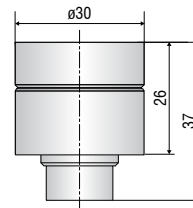

#### KSH10 sensor

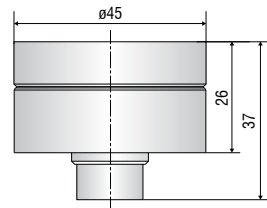

#### Scope of supply:

- KSH sensor
- Sensor cable 1 m
- Controller
- PC6200 3/4 supply and trigger cable (3m)

#### Accessories:

- SCAC3/5 signal output cable analog (3 m)

Sensor cable	Cable CCx,x / CCx,x/90	Cable CCmx,x / CCmx,x/90	Cable CCgx,x / CCgx,x/90
Description	Low-outgassing cable up to 4 m length, for applications in clean rooms	Low-outgassing cable up to 4.2 m length, for applications in clean rooms, UHV and EUV	Robust cable up to 8 m length, for industrial applications
Temperature stability	-100 °C to +200 °C	-100 °C to +200 °C	-20 °C to +80 °C (permanent) -20 °C to +100 °C (10;000 h)
Outer diameter	3.1 mm ±0.1 mm	2.1 mm ±0.1 mm	3.1 mm ±0.1 mm
Bending radius	3x cable diameter during installation; 7x cable diameter for movement; 12x cable diameter recommend at continuous movement		

Design	Cable with connector type C for sensors CS005 / CS02 / CS05 / CSE05 / CS08 / CSE1						Cable with connector type B for sensors CS1 / CS1HP / CSE1,25 / CS2 / CSE2 / CS3 / CSE3 / CS5 / CS10					
	2 x straight connector			1 x straight / 1 x 90° connector			2 x straight connector			1 x straight / 1 x 90° connector		
Model	CCx,xC	CCmx,xC	CCgx,xC	CCx,xC/90	CCmx,xC/90	CCgx,xC/90	CCx,xB	CCmx,xB	CCgx,xB	CCx,xB/90	CCmx,xB/90	CCgx,xB/90
Standard 1 m	•		•	•		•	•		•	•		•
1.4 m		•			•			•			•	
2 m	•		•	•		•	•		•	•		•
2.8 m		•			•			•			•	
3 m	•			•		•	•		•	•		•
4 m			•			•			•			•
4.2 m		•			•			•			•	
6 m			•			•			•			•
8 m			•			•			•			•

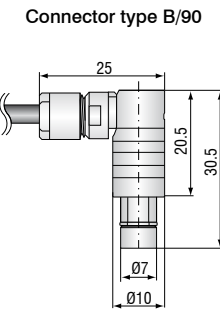
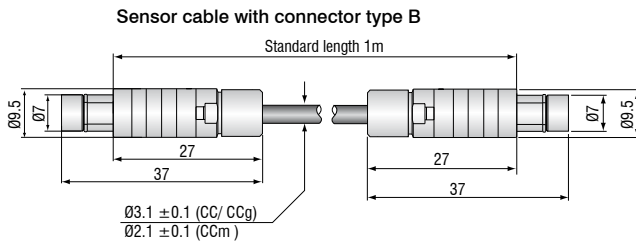
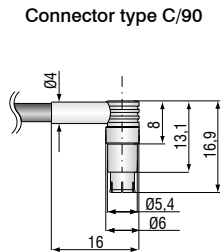
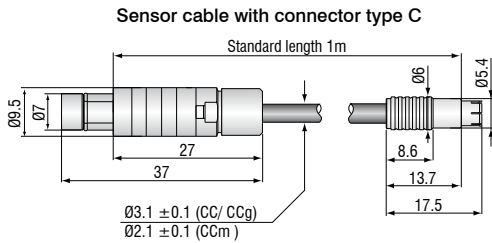

Accessories	capaNCDT	6110	6200	6500
<b>MC2.5</b> Micrometer for sensor calibration, range 0 - 2.5 mm, Resolution 0.1 µm. Suitable for sensors CS005 to CS2		•	•	•
MC25D Digital micrometer for sensor calibration, range 0 - 25 mm, adjustable offset (zero). Suitable for all sensors.		•	•	•
<b>HV/B</b> Vacuum feed through triaxial		•	•	•
<b>UHV/B</b> Vacuum feed through triaxial for ultra-high vacuum		•	•	•
<b>PC6200-3/4</b> Power/trigger cable, 4 pin, 3 m			•	
<b>SCAC3/4</b> Signal output cable, (necessary for multi-channel applications), 4 pin, 3 m			•	
<b>SCAC3/5</b> Signal output cable, analog, 5 pin, 3 m		•		
<b>SC6000-1,0</b> Synchronization cable, 5 pin, 1 m			•	•
<b>CA5</b> Pre-amplifier cable 5 pin, 5 m				•
<b>PS2020</b> Power supply for DIN rail mounting; Input 230 VAC (115 VAC); Output 24 VDC / 2.5 A; L/W/H 120x120x40 mm		•	•	

**HV/B Vacuum feed through** (Art.-no. 0323050)

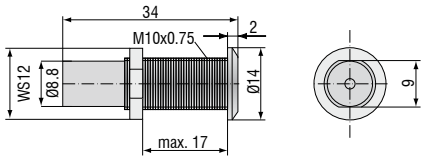

Max. leak rate  $1 \times 10^{-7}$  mbar · l s<sup>-1</sup>, compatible with connector type B

**UHV/B Vacuum feed triax weldable** (Art.-no. 0323346)

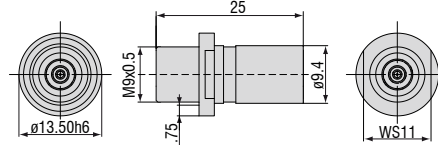

Max. leak rate  $1 \times 10^{-9}$  mbar · l s<sup>-1</sup>, compatible with connector type B

**UHV/B Vacuum feed triax with flange CF16** (Art.-no. 0323349)

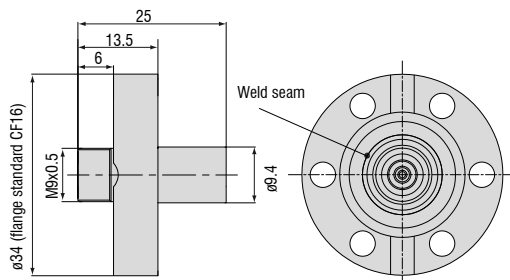

Max. leak rate  $1 \times 10^{-9}$  mbar · l s<sup>-1</sup>, compatible with connector type B

**UHV/B Vacuum feed triax screwable** (Art.-no. 0323370)

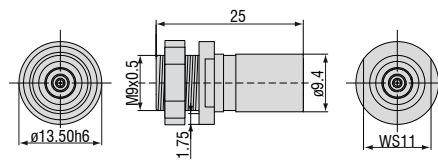

Max. leak rate  $1 \times 10^{-9}$  mbar · l s<sup>-1</sup>, compatible with connector type B

**SCAC3/4 Signal output cable** (Art.-no. 2902104)

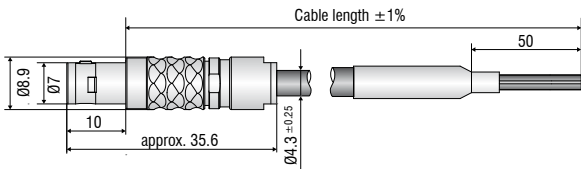

**SCAC3/5 Signal output cable** (Art.-no. 2902112)

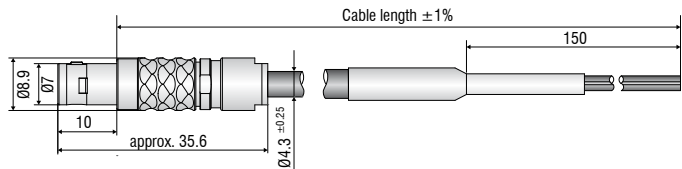

**PC6200-3/4 Power-/trigger cable** (Art.-no. 2901881)

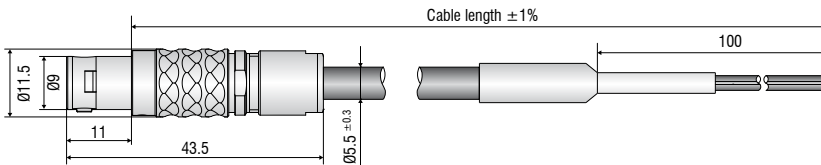

**SC6000-1,0 Synchronization cable** (Art.-no. 2903473)

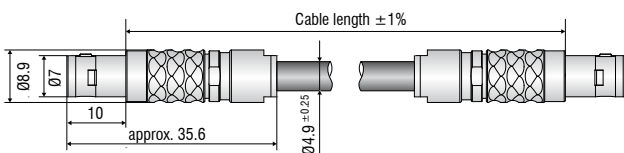

**CA5 Preamplifier cable** (Art.-no. 2903180)

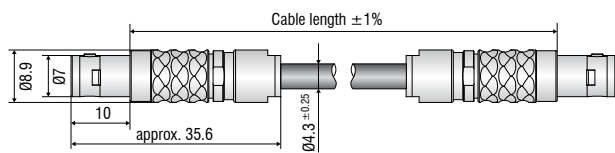

## High performance sensors made by Micro-Epsilon



Sensors and systems for displacement and position



Sensors and measurement devices for non-contact temperature measurement



2D/3D profile sensors (laser scanner)



Optical micrometers, fiber optic sensors and fiber optics



Color recognition sensors, LED analyzers and color inline spectrometer



Measurement and inspection systems