



# More Precision

**eddyNCDT** // Inductive sensors based on eddy currents



▲▲▲▲  
Measurement direction  
▲  
Cable side

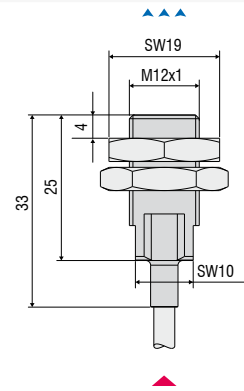
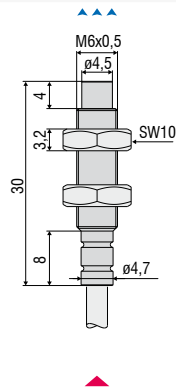

Sensor type		ES-U1	ES-S2
Measuring range		1 mm	2 mm
Start of measuring range		0.1 mm	0.2 mm
Resolution <sup>1) 2) 3)</sup>		0.02 $\mu\text{m}$	0.04 $\mu\text{m}$
Linearity <sup>1)</sup>	3-point linearization	$\leq \pm 2 \mu\text{m}$	$\leq \pm 4 \mu\text{m}$
	5-point linearization <sup>4)</sup>	$\leq \pm 1 \mu\text{m}$	$\leq \pm 2 \mu\text{m}$
Temperature stability <sup>1) 2)</sup>		$\leq 0.15 \mu\text{m} / \text{K}$	$\leq 0.3 \mu\text{m} / \text{K}$
Temperature compensation		+10 ... +180 °C	+10 ... +180 °C
Min. target size (flat)	Operation	$\varnothing 18 \text{ mm}$	$\varnothing 18 \text{ mm}$
Sensor type		unshielded	shielded
Connection		integrated cable, axial standard length 3 m; 1 m, 6 m, 9 m optional <sup>5)</sup>	integrated cable, axial standard length 3 m; 1 m, 6 m, 9 m optional <sup>5)</sup>
Mounting		cable gland (M6)	cable gland (M12)
Temperature range	Storage	-50 ... +180 °C	-50 ... +200 °C
	Operation	-20 ... +180 °C	-20 ... +200 °C
Pressure resistance	Front	20 bars	20 bars
	Rear	5 bars	5 bars
Shock (DIN-EN 60068-2-29)		30 g	30 g
Vibration (DIN-EN 60068-2-6)		15 g	15 g
Protection class (DIN-EN 60529)		IP68 (plugged)	IP68 (plugged)
Material		stainless steel and plastic	stainless steel and plastic
Weight		2.4 g (without nuts)	11 g (without nuts)

FSO = Full Scale Output

<sup>1)</sup> valid for operation with DT306x controller, referred to nominal measuring range

<sup>2)</sup> relates to midrange

<sup>3)</sup> RMS value of the signal noise, static (20 Hz)

<sup>4)</sup> only available with controller DT3061

<sup>5)</sup> Length tolerance cable: +0.5 m / +1.25 m / +2.35 m / +3.5 m

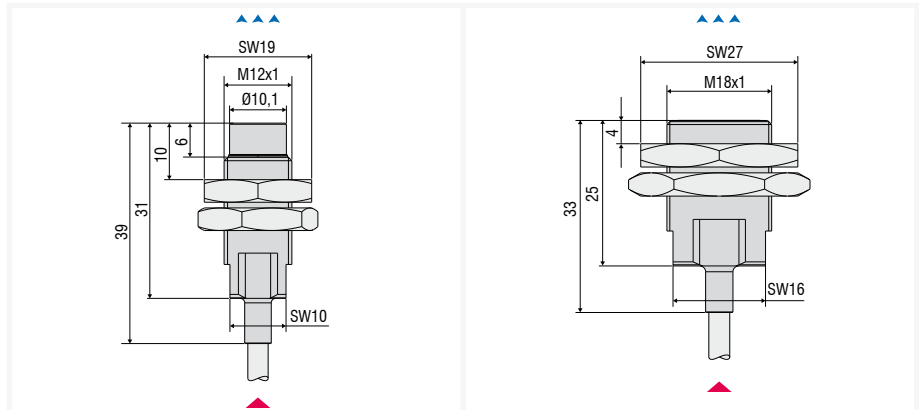
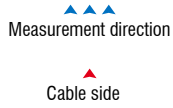

Sensor type		ES-U3	ES-S4
Measuring range		3 mm	4 mm
Start of measuring range		0.3 mm	0.4 mm
Resolution <sup>1) 2) 3)</sup>		0.06 µm	0.08 µm
Linearity <sup>1)</sup>	3-point linearization	≤ ± 6 µm	≤ ± 8 µm
	5-point linearization <sup>4)</sup>	≤ ± 3 µm	≤ ± 4 µm
Temperature stability <sup>1) 2)</sup>		≤ 0.45 µm / K	≤ 0.6 µm / K
Temperature compensation		+10 ... +180 °C	+10 ... +180 °C
Min. target size (flat)	Operation	Ø 36 mm	Ø 27 mm
Sensor type		unshielded	shielded
Connection		integrated cable, axial standard length 3 m; 1 m, 6 m, 9 m optional <sup>5)</sup>	integrated cable, axial standard length 3 m; 1 m, 6 m, 9 m optional <sup>5)</sup>
Mounting		cable gland (M12)	cable gland (M18)
Temperature range	Storage	-50 ... +200 °C	-50 ... +200 °C
	Operation	-20 ... +200 °C	-20 ... +200 °C
Pressure resistance	Front	20 bars	20 bars
	Rear	5 bars	5 bars
Shock (DIN-EN 60068-2-29)		30 g	30 g
Vibration (DIN-EN 60068-2-6)		15 g	15 g
Protection class (DIN-EN 60529)		IP68 (plugged)	IP68 (plugged)
Material		stainless steel and plastic	stainless steel and plastic
Weight		12 g (without nuts)	30 g (without nuts)

FSO = Full Scale Output

<sup>1)</sup> valid for operation with DT306x controller, referred to nominal measuring range

<sup>2)</sup> relates to midrange

<sup>3)</sup> RMS value of the signal noise, static (20 Hz)

<sup>4)</sup> only available with controller DT3061

<sup>5)</sup> Length tolerance cable: +0.5 m / +1.25 m / +2.35 m / +3.5 m

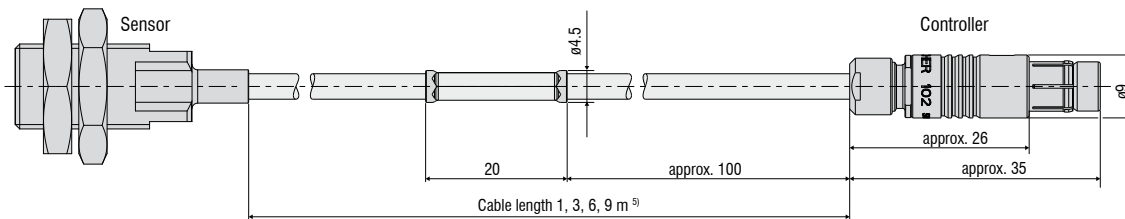

**Cables**

Cable design	coaxial
Sheath material	FKM
Temperature stability	-20...+200 °C
Outer diameter	3.6 mm ± 0.2 mm
Bending radius	static: ≥ 18 mm
	dynamic: ≥ 36 mm
Suitable for use with robots	no

**Connector (controller)**

Model	triaxial connector, type B
Locking method	push-pull
Protection class	IP 68 (connected)
Temperature stability	-20 ... +200 °C
Material (housing)	nickel- and chrome-plated brass
Mechanical service life	10,000 cycles



- Micrometer accuracy
- Ideal for high speed measurements: frequency response up to 100 kHz (-3dB)
- Numerous sensor models even for customer-specific applications
- Robust and industrial-grade sensor designs
- Synchronized multi-channel measurement

The eddyNCDT 3300 eddy current measuring system is considered one of the most powerful displacement measuring systems in the world. Due to a mature technical design, the system offers numerous benefits to customers in multiple application areas such as manufacturing automation, machine monitoring and quality control.

#### Multifunctional controller

The eddyNCDT 3300 controllers are equipped with high performance processors for reliable signal processing and further processing. The three-point linearization feature enables almost fully automatic linearization, which provides high accuracies for any metallic target and installation environment. The operation is supported by a dialog-aided graphical display.

#### Linearization and calibration

eddyNCDT 3300 systems can be individually linearized and calibrated by the user. Therefore, optimum measurement accuracies will always be achieved, even in the case of difficult target materials or harsh ambient conditions. The adjustment is made using three distance points (①, ②, ③) which are defined by a reference standard.

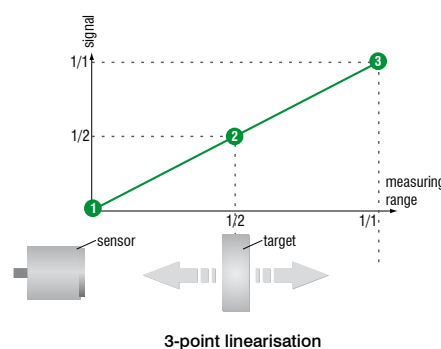

#### Field calibration ensures highest precision

In order to achieve maximum precision, eddyNCDT 3300 provides the field calibration function for achieving extremely precise measurement results. The following influences are taken into account:

- A: Different target materials**
- B: Different target sizes (measuring spot)**
- C: Target shape**
- D: Side preattenuation**
- E: Target tilt angle**

The measuring range can also be extended using the field calibration.

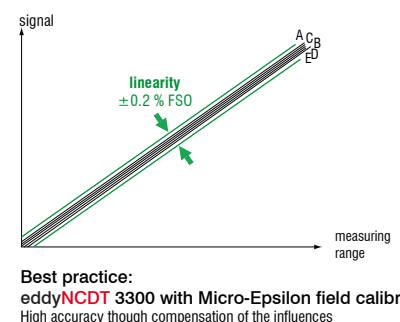
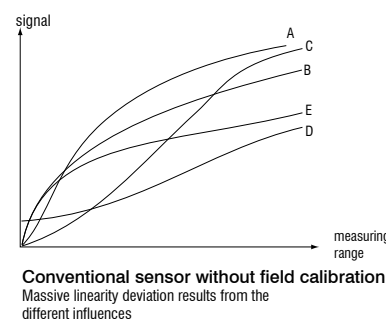

Controller	DT3300	DT3301
Linearity	$\leq \pm 0.2\%$ FSO	
Resolution <sup>2)</sup>	up to 25Hz	$\leq 0.005\%$ FSO ( $\leq 0.01\%$ FSO with ES04, ES05 and EU05)
	up to 2.5 kHz	$\leq 0.01\%$ FSO
	up to 25/100 kHz	$\leq 0.2\%$ FSO
Frequency response	selectable 25 kHz / 2.5 kHz / 25 Hz (-3 dB); 100 kHz for measuring ranges $\leq 1$ mm	
Temperature compensation range	10 ... 100 °C (option TCS: -40 ... 180 °C) <sup>3)</sup>	
Temperature range	Controller	+5 ... +50 °C
Outputs	selectable 0 ... 5 V / 0 ... 10 V / $\pm 2.5$ V / $\pm 5$ V / $\pm 10$ V (or inverted) / 4 ... 20 mA (load 350 Ohm)	
Power supply	$\pm 12$ VDC / 100 mA, 5.2 VDC / 220 mA <sup>1)</sup>	11 ... 32 VDC / 700 mA
Synchronization	via cable PSC 30 (accessories)	via cable E SC 30 (accessories)
Electromagnetic compatibility	according to EN 50081-2 / EN 61000-6-2	
Controller functions	limit value monitoring, auto-zero, peak-to-peak, minimum, maximum, average, storage of 3 characteristics (calibrations)	

FSO = Full Scale Output

Reference material: aluminum (non-ferromagnetic) or steel DIN 1.0037 (ferromagnetic)

Reference temperature for reported data is 20 °C (70 °F); resolution and temperature stability refer to midrange

Data may differ with magnetic inhomogeneous materials.

<sup>1)</sup> Additionally 24 VDC for external reset and limit switch

<sup>2)</sup> Resolution data are based on noise peak-to-peak values

<sup>3)</sup> Temperature stability may differ with TCS option

#### Controller dimensions

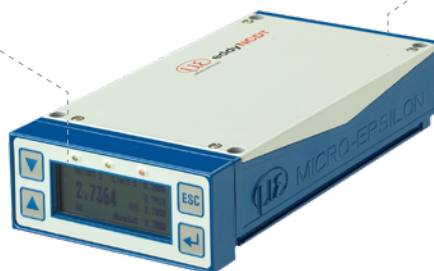
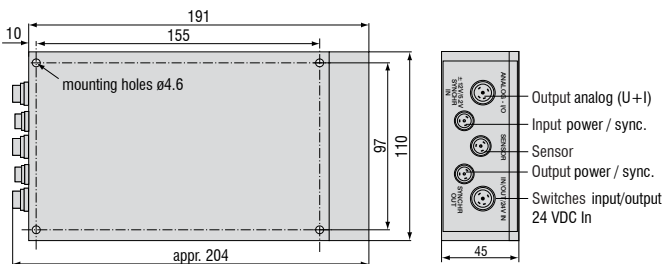

#### Outputs

- Voltage/current
- Metric/Inch and graphic display
- Display of auto-zero, peak-to-peak value, minimum, maximum
- Scalable display for conversion to indirect measured values

#### Quadruple limit switch

- Two freely definable minimum and maximum limit values
- Individual switching threshold
- LED display for upper and lower limit warnings

#### Automatic calibration

- Three-point linearization for optimum on-site calibration

#### Four configurations can be stored

- Factory calibration and three individual characteristic curves can be stored
- Simple microprocessor-controlled single-cycle calibration

**Tilt angle and measurement signal**

The eddyNCDT non-contacting displacement measuring system is frequently used since it provides excellent linearity and high resolution. This high resolution is achieved with right angle position, only. Sometimes, it is not possible to exactly install the sensor at right angles due to the installation environment. In this case, the measured

values slightly deviate from the values measured in right angle position. Hence it is important to know the influence to the measuring signal if the sensor is tilted. The following graphs show the influence to the measuring signal of a tilted sensor.

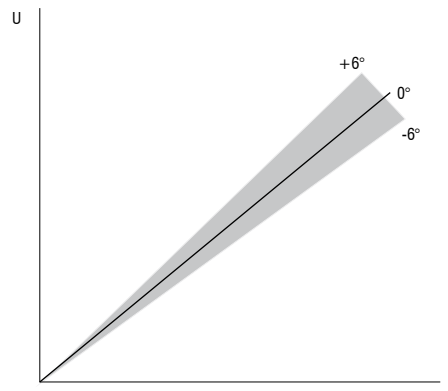
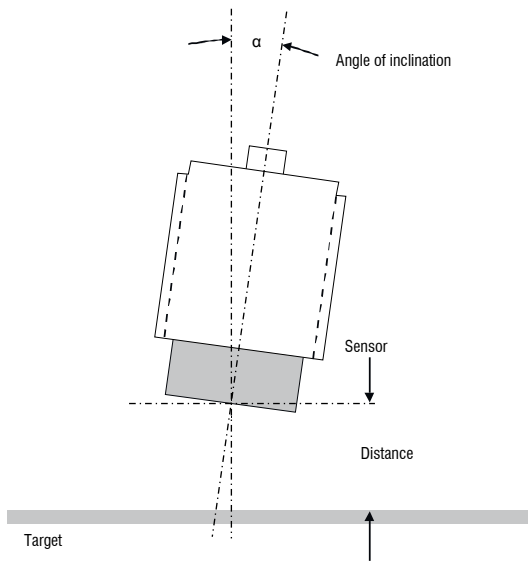

Example: Tilt a sensor 6° with 3 mm measuring range, means a deviation of 5µm at 2/3 measuring distance.

A permanent tilt angle can already be lodged at the controller with the 3-point linearization. This avoids an influence of this tilt angle to the signal.

Tilt angles, the controller not linearized for, cause deviations of the measured values in comparison to right angled measurements.

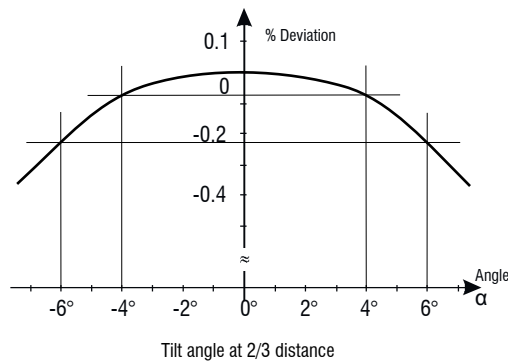
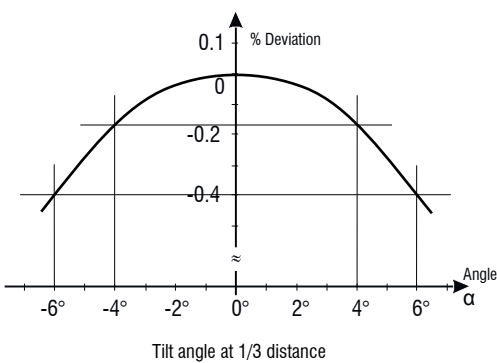

The extent of deviation differs from sensor to sensor. These diagrams were taken with a U6 sensor and aluminum target. The diagrams show, that an inclination of  $\pm 4$  degrees can be accepted and neglected in most applications.

A tilt angle of more than 6 degree is rather possible with unshielded sensors than with shielded, but should be avoided. In principle, only a special linearized sensor provides a precise signal.



## High performance sensors made by Micro-Epsilon



Sensors and systems for displacement and position



Sensors and measurement devices for non-contact temperature measurement



2D/3D profile sensors (laser scanner)



Optical micrometers, fiber optic sensors and fiber optics



Color recognition sensors, LED analyzers and color online spectrometer



Measurement and inspection systems