

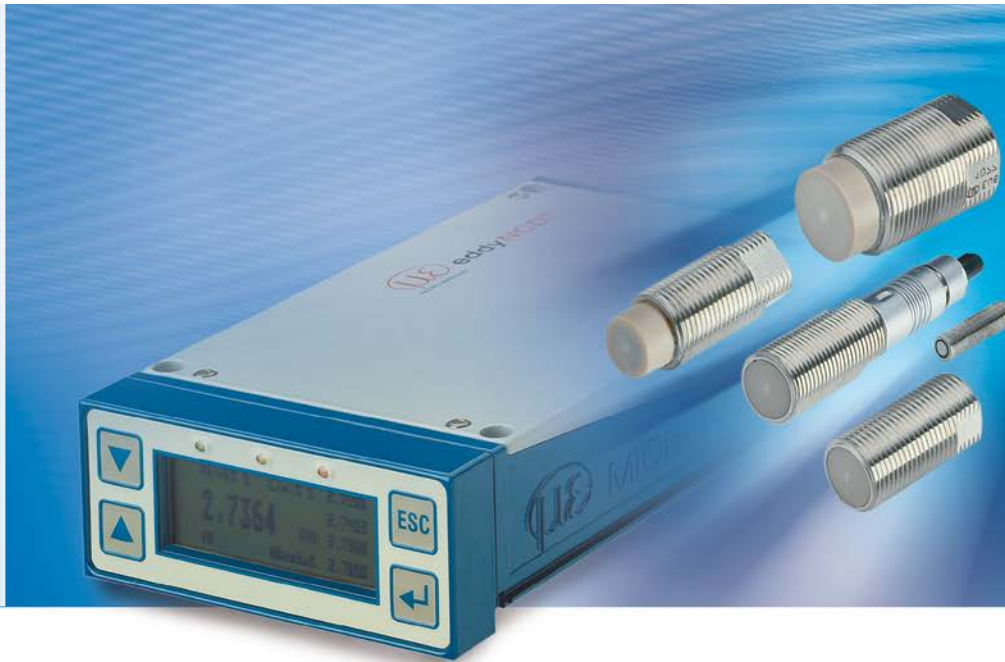

# More Precision

**eddyNCDT** // Inductive sensors based on eddy currents





- Micrometer accuracy
- Ideal for high speed measurements: frequency response up to 100 kHz (-3dB)
- Numerous sensor models even for customer-specific applications
- Robust and industrial-grade sensor designs
- Synchronized multi-channel measurement

The eddyNCDT 3300 eddy current measuring system is considered one of the most powerful displacement measuring systems in the world. Due to a mature technical design, the system offers numerous benefits to customers in multiple application areas such as manufacturing automation, machine monitoring and quality control.

#### Multifunctional controller

The eddyNCDT 3300 controllers are equipped with high performance processors for reliable signal processing and further processing. The three-point linearization feature enables almost fully automatic linearization, which provides high accuracies for any metallic target and installation environment. The operation is supported by a dialog-aided graphical display.

#### Linearization and calibration

eddyNCDT 3300 systems can be individually linearized and calibrated by the user. Therefore, optimum measurement accuracies will always be achieved, even in the case of difficult target materials or harsh ambient conditions. The adjustment is made using three distance points (①, ②, ③) which are defined by a reference standard.

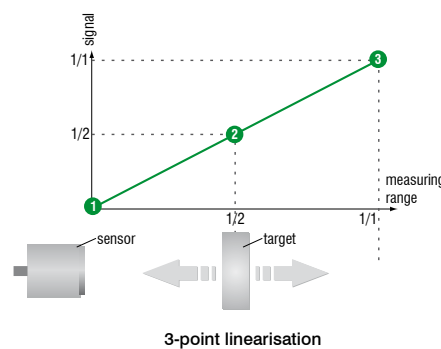

#### Field calibration ensures highest precision

In order to achieve maximum precision, eddyNCDT 3300 provides the field calibration function for achieving extremely precise measurement results. The following influences are taken into account:

- A: Different target materials**
- B: Different target sizes (measuring spot)**
- C: Target shape**
- D: Side preattenuation**
- E: Target tilt angle**

The measuring range can also be extended using the field calibration.

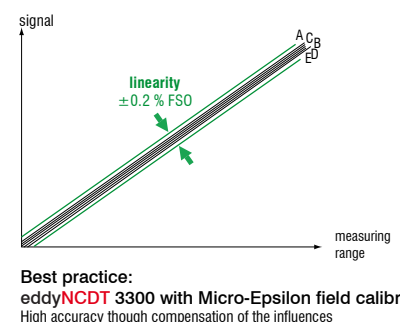
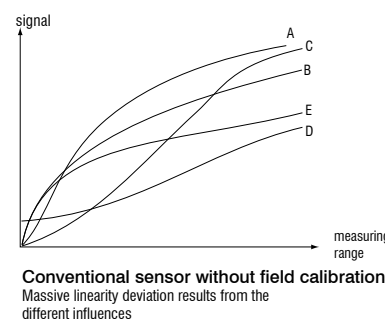

Controller	DT3300	DT3301
Linearity	$\leq \pm 0.2\%$ FSO	
Resolution <sup>2)</sup>	up to 25Hz	$\leq 0.005\%$ FSO ( $\leq 0.01\%$ FSO with ES04, ES05 and EU05)
	up to 2.5 kHz	$\leq 0.01\%$ FSO
	up to 25/100 kHz	$\leq 0.2\%$ FSO
Frequency response	selectable 25 kHz / 2.5 kHz / 25 Hz (-3 dB); 100 kHz for measuring ranges $\leq 1$ mm	
Temperature compensation range	10 ... 100 °C (option TCS: -40 ... 180 °C) <sup>3)</sup>	
Temperature range	Controller	+5 ... +50 °C
Outputs	selectable 0 ... 5 V / 0 ... 10 V / $\pm 2.5$ V / $\pm 5$ V / $\pm 10$ V (or inverted) / 4 ... 20 mA (load 350 Ohm)	
Power supply	$\pm 12$ VDC / 100 mA, 5.2 VDC / 220 mA <sup>1)</sup>	11 ... 32 VDC / 700 mA
Synchronization	via cable PSC 30 (accessories)	via cable E SC 30 (accessories)
Electromagnetic compatibility	according to EN 50081-2 / EN 61000-6-2	
Controller functions	limit value monitoring, auto-zero, peak-to-peak, minimum, maximum, average, storage of 3 characteristics (calibrations)	

FSO = Full Scale Output

Reference material: aluminum (non-ferromagnetic) or steel DIN 1.0037 (ferromagnetic)

Reference temperature for reported data is 20 °C (70 °F); resolution and temperature stability refer to midrange

Data may differ with magnetic inhomogeneous materials.

<sup>1)</sup> Additionally 24 VDC for external reset and limit switch

<sup>2)</sup> Resolution data are based on noise peak-to-peak values

<sup>3)</sup> Temperature stability may differ with TCS option

#### Controller dimensions

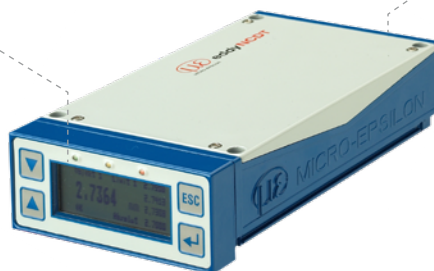
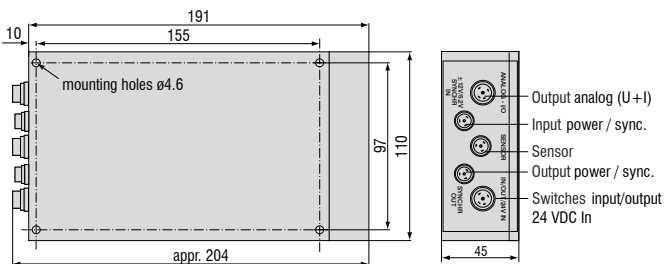

#### Outputs

- Voltage/current
- Metric/Inch and graphic display
- Display of auto-zero, peak-to-peak value, minimum, maximum
- Scalable display for conversion to indirect measured values

#### Quadruple limit switch

- Two freely definable minimum and maximum limit values
- Individual switching threshold
- LED display for upper and lower limit warnings

#### Automatic calibration

- Three-point linearization for optimum on-site calibration

#### Four configurations can be stored

- Factory calibration and three individual characteristic curves can be stored
- Simple microprocessor-controlled single-cycle calibration

▲▲▲▲  
Measurement direction  
▲  
Connector side

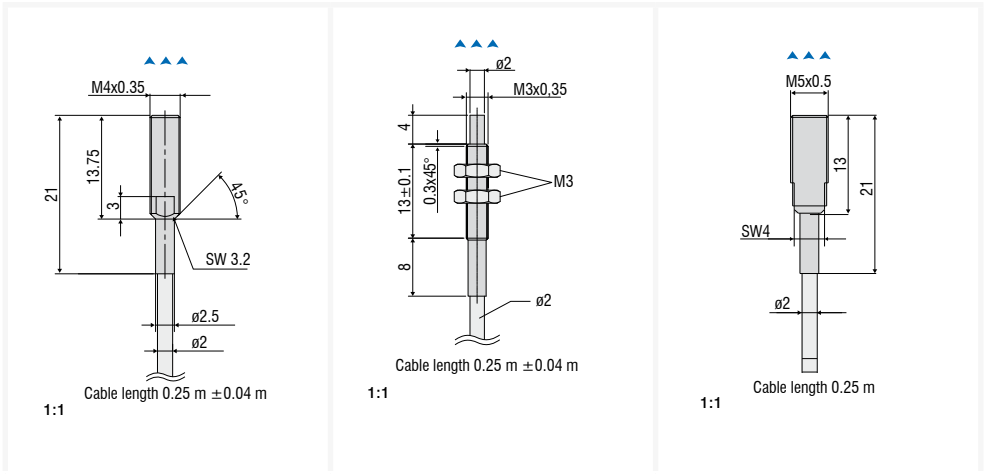

Sensor type	ES04	EU05	ES08
Design	shielded	unshielded	shielded
Measuring range	0.4 mm	0.4 mm	0.8 mm
Offset distance	0.04 mm	0.05 mm	0.08 mm
Linearity	$\leq \pm 0.8 \mu\text{m}$	$\leq \pm 1 \mu\text{m}$	$\leq \pm 1.6 \mu\text{m}$
Resolution	$0.02 \mu\text{m}$	$0.025 \mu\text{m}$	$0.04 \mu\text{m}$
Temperature stability (MMR)	$\leq \pm 0.06 \mu\text{m}/^\circ\text{C}$	$\leq \pm 0.075 \mu\text{m}/^\circ\text{C}$	$\leq \pm 0.12 \mu\text{m}/^\circ\text{C}$
Temperature (max.)	150 °C	150 °C	150 °C
Pressure resistance (sensor front)	100 bars	-	20 bars
Integrated cable/length	approx. 0.25 m	approx. 0.25 m	approx. 0.25 m
Temperature (sensor cable)	180 °C	180 °C	180 °C
Material (sensor housing)	stainless steel	stainless steel and ceramics	stainless steel and plastic

MMR = midrange

ECx sensor cable, length is selectable up to  $x \leq 15\text{m}$

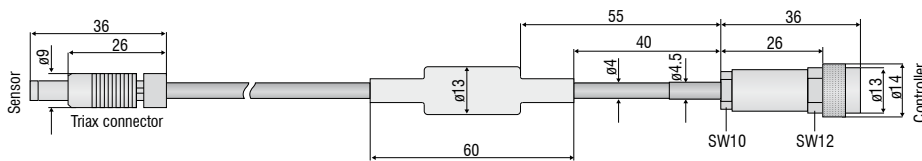

ECx/1 extension cable for solder connection, length is selectable up to  $x \leq 15\text{ m}$

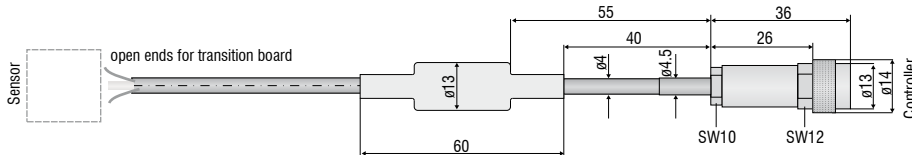

ECx/2 extension cable for plug connection, length is selectable up to  $x \leq 15\text{ m}$

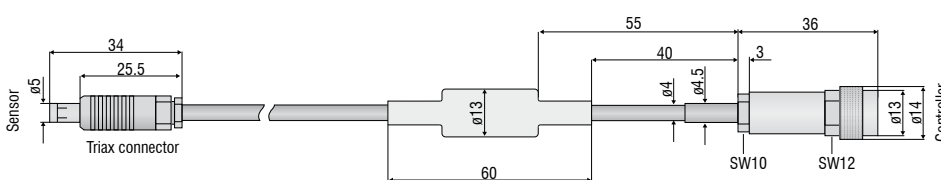

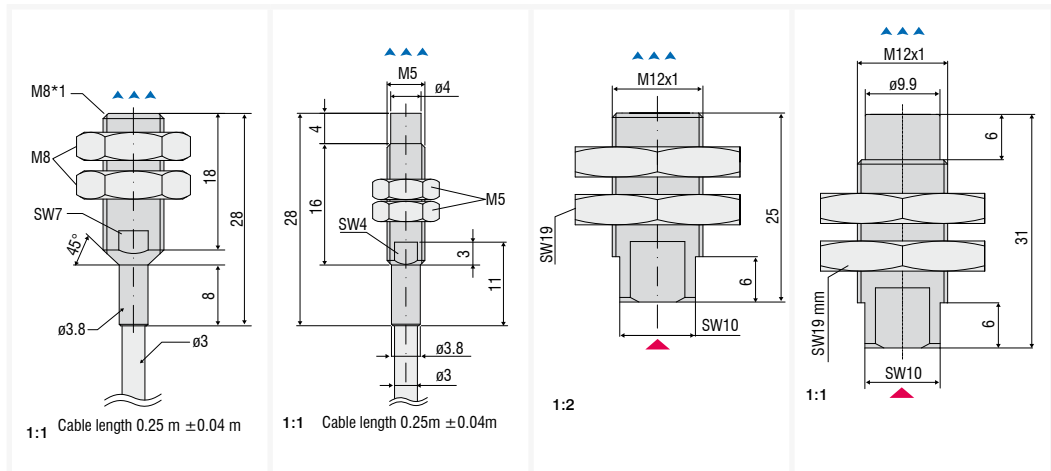
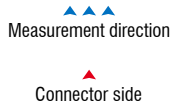

Sensor type	ES1	EU1	ES2	EU3
Design	shielded	unshielded	shielded	unshielded
Measuring range	1 mm	1 mm	2 mm	3 mm
Offset distance	0.1 mm	0.1 mm	0.2 mm	0.3 mm
Linearity	$\leq \pm 2 \mu\text{m}$	$\leq \pm 2 \mu\text{m}$	$\leq \pm 4 \mu\text{m}$	$\leq \pm 6 \mu\text{m}$
Resolution	$0.05 \mu\text{m}$	$0.05 \mu\text{m}$	$0.1 \mu\text{m}$	$0.15 \mu\text{m}$
Temperature stability (MMR)	$\leq \pm 0.15 \mu\text{m}/^\circ\text{C}$	$\leq \pm 0.15 \mu\text{m}/^\circ\text{C}$	$\leq \pm 0.3 \mu\text{m}/^\circ\text{C}$	$\leq \pm 0.45 \mu\text{m}/^\circ\text{C}$
Temperature (max.)	150 °C	150 °C	150 °C	150 °C
Pressure resistance (sensor front)	-	-	20 bars	20 bars
Integrated cable/length	approx. 0.25 m	approx. 0.25 m	-	-
Temperature (sensor cable)	180 °C	180 °C	-	-
Material (sensor housing)	stainless steel and plastic	stainless steel and plastic	stainless steel and plastic	stainless steel and plastic

MMR = midrange

**Cable**

Cable design	coaxial with sheath wire
Sheath material	FEP/Fluoropolymer thermoplastics
Temperature resistance	-30 °C to +200 °C
Outer diameter	3.9 mm ± 0.1 mm
Bending radius	One-time bending during installation: 2 x cable diameter Minimum bending radius for movement: 5 x cable diameter Optimum bending radius at continuous movement: 10 x cable diameter
Suitable for use with robots	no

**Plug Model**

	Controller side	Sensor side	ECx/1	ECx/2
Type	5-pin socket, cable socket	plug (male), triaxial	5-pin plug (male)	plug (male), triaxial
Locking method:	screw	push-pull	screw	push-pull
Protection class	IP67	IP67 (when connected)	IP67 (when connected)	IP68
Temperature stability	-30 °C to +85 °C	-30 °C to +150 °C	-40 °C to +85 °C	-65 °C to +135 °C
Material housing	brass nickel-plated	brass nickel-plated, mat	brass nickel-plated	brass nickel-plated, mat
Mechanical service life	> 500 mating cycles	> 5,000 mating cycles	> 500 mating cycles	> 5,000 mating cycles

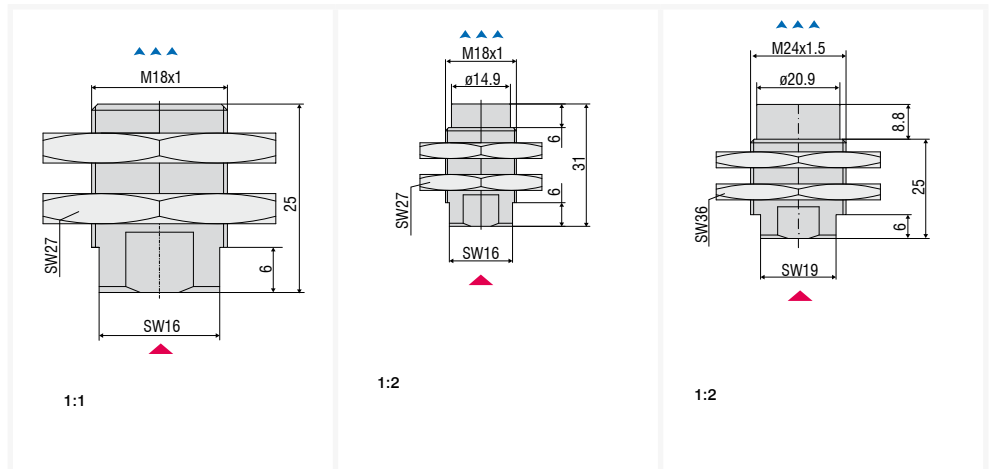
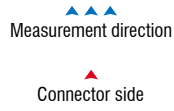

Sensor type	ES4	EU6	EU8
Design	shielded	unshielded	unshielded
Measuring range	4 mm	6 mm	8 mm
Offset distance	0.4 mm	0.6 mm	0.8 mm
Linearity	$\leq \pm 8 \mu\text{m}$	$\leq \pm 12 \mu\text{m}$	$\leq \pm 16 \mu\text{m}$
Resolution	$0.2 \mu\text{m}$	$0.3 \mu\text{m}$	$0.4 \mu\text{m}$
Temperature stability (MMR)	$\leq \pm 0.6 \mu\text{m}/^\circ\text{C}$	$\leq \pm 0.9 \mu\text{m}/^\circ\text{C}$	$\leq \pm 1.2 \mu\text{m}/^\circ\text{C}$
Temperature (max.)	150 °C	150 °C	150 °C
Pressure resistance (sensor front)	20 bars	20 bars	20 bars
Integrated cable/length	-	-	-
Temperature (sensor cable)	-	-	-
Material (sensor housing)	stainless steel and plastic	stainless steel and plastic	stainless steel and plastic

MMR = midrange

**ECEx sensor cable extension**, length is selectable up to  $x \leq 15$  m

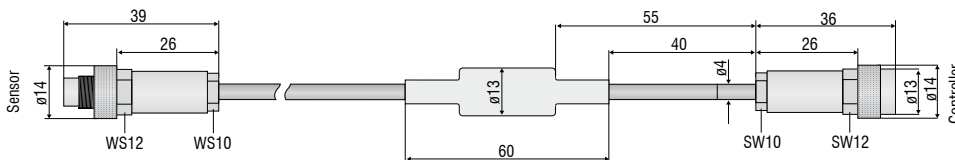

**ECx/90 sensor cable with 90° connector (sensor-sided)**, length is selectable up to  $x \leq 15$  m

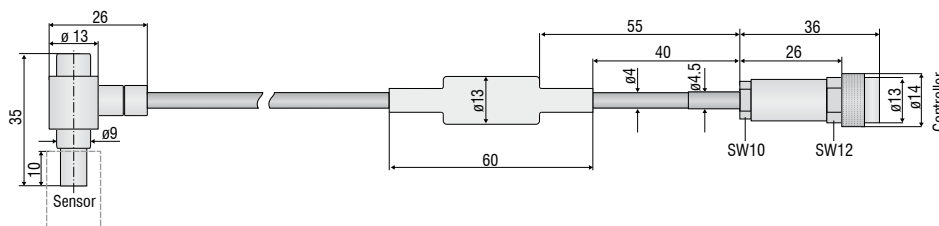

▲▲▲▲  
Measurement direction  
▲  
Connector side

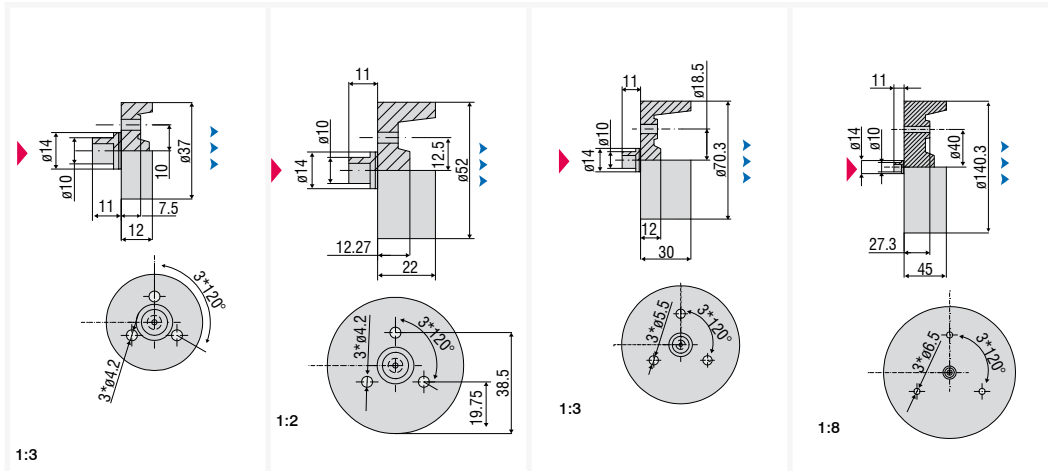

Sensor type	EU15	EU22	EU40	EU80
Design	unshielded	unshielded	unshielded	unshielded
Measuring range	15 mm	22 mm	40 mm	80 mm
Offset distance	1.5 mm	2.2 mm	4 mm	8 mm
Linearity	≤ ± 30 μm	≤ ± 44 μm	≤ ± 80 μm	≤ ± 160 μm
Resolution	0.75 μm	1.1 μm	2 μm	4 μm
Temperature stability (MMR)	≤ ± 2.25 μm/°C	≤ ± 3.3 μm/°C	≤ ± 6 μm/°C	≤ ± 12 μm/°C
Temperature (max.)	150 °C	150 °C	150 °C	150 °C
Pressure resistance (sensor front)	-	-	-	-
Integrated cable/length	-	-	-	-
Temperature (sensor cable)	-	-	-	-
Material (sensor housing)	epoxy	epoxy	epoxy	epoxy

MMR = midrange

**Cable**

Cable design: coaxial with sheath wire  
 Sheath material: FEP/Fluoropolymer thermoplastics  
 Temperature resistance: -30°C to +200°C  
 Outer diameter: 3.9 mm ± 0.1 mm  
 Bending radius: One-time bending during installation: 2 x cable diameter  
 Minimum bending radius for movement: 5 x cable diameter  
 Optimum bending radius at continuous movement: 10 x cable diameter  
 Suitable for use with robots: no

**Plug Model**

Type: 5-pin socket, cable socket screw  
 Locking method: screw  
 Protection class: IP67  
 Temperature stability: -30 °C to +85 °C  
 Material housing: brass nickel-plated  
 Mechanical service life: > 500 mating cycles

**Controller side**

5-pin socket, cable socket screw  
 IP67  
 -30 °C to +85 °C  
 brass nickel-plated  
 > 500 mating cycles

**Sensor side**

**ECEx**  
 5-pin plug (male) screw  
 IP67 (when connected)  
 -30 °C to +85 °C  
 brass nickel-plated  
 > 500 mating cycles

**ECx/90**

plug (male), triaxial, angle push-pull  
 IP67 (when connected)  
 -65 °C to +135 °C  
 brass nickel-plated, mat  
 > 5000 mating cycles



### Subminiature sensors for restricted spaces

As well as standard sensors in conventional designs, miniature sensors with the smallest possible dimensions that achieve high precision measurement results are also available. Pressure-resistant versions, screened housings, ceramic types and other special features characterize these sensors, which achieve highly accurate measurement results despite their small dimensions. The miniature sensors are primarily used in high pressure applications, for example, in combustion engines.

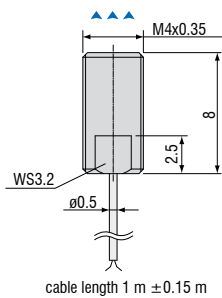

2:1

#### ES04/180(25) Shielded Sensor

Measuring range 0.4 mm  
 Temperature stability  $\leq \pm 0.025\%$  FSO/°C  
 Connection: integrated coaxial cable 1 m ( $\varnothing 0.5$  mm), short silicon tube at cable exit  
 Pressure resistance (static): front 100 bar  
 Max. operating temperature: 180 °C  
 Housing material: stainless steel  
 Sensor cable: ECx/1 or ECx/2, length  $\leq 6$  m

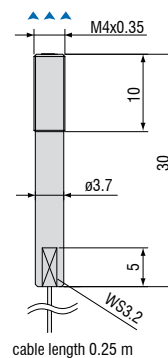

1:1

#### ES04/180(27) Shielded Sensor

Measuring range 0.4 mm  
 Temperature stability  $\leq \pm 0.025\%$  FSO/°C  
 Connection: integrated coaxial cable 0.25 m ( $\varnothing 0.5$  mm) with solder connection board  
 Pressure resistance (static): front 100 bar  
 Max. operating temperature: 180 °C  
 Housing material: stainless steel  
 Sensor cable: ECx/1, length  $\leq 6$  m

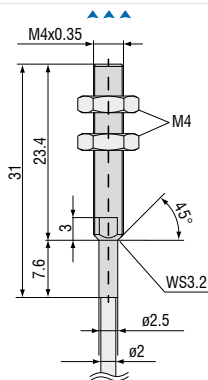

1:1

#### ES04(34) Shielded Sensor

Measuring range 0.4 mm  
 Temperature stability  $\leq \pm 0.025\%$  FSO/°C  
 Connection: integrated coaxial cable 0.25 m ( $\varnothing 2$  mm) with sealed triaxial connector  
 Pressure resistance (static): front 100 bar / rear side splash water  
 Max. operating temperature: 150 °C  
 Housing material: stainless steel and ceramic  
 Sensor cable: ECx, length  $\leq 6$  m

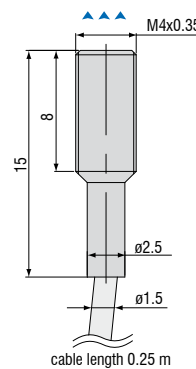

2:1

#### ES04(35) Shielded Sensor

Measuring range 0.4 mm  
 Temperature stability  $\leq \pm 0.025\%$  FSO/°C  
 Connection: integrated coaxial cable 0.25 m ( $\varnothing 1.5$  mm) with sealed triaxial connector  
 Pressure resistance (static): front 100 bar / rear side 5 bar  
 Max. operating temperature: 150 °C  
 Housing material: stainless steel and ceramic  
 Sensor cable: ECx/1, length  $\leq 6$  m

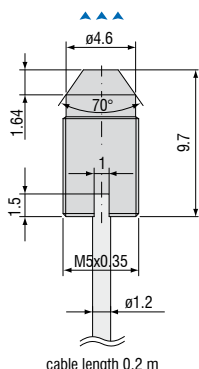

2:1

#### ES04(44) Shielded Sensor

Measuring range 0.4 mm  
 Temperature stability  $\leq \pm 0.025\%$  FSO/°C  
 Connection: integrated coaxial cable 0.2 m ( $\varnothing 1.2$  mm) with sealed triaxial connector  
 Pressure resistance (static): front 100 bar / rear side splash water  
 Max. operating temperature: 150 °C  
 Housing material: stainless steel and ceramic  
 Sensor cable: ECx, length  $\leq 6$  m

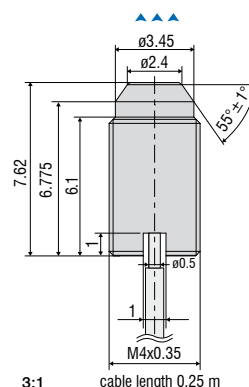

3:1

#### ES04(70) Shielded Sensor

Measuring range 0.4 mm  
 Temperature stability  $\leq \pm 0.025\%$  FSO/°C  
 Connection: integrated coaxial cable 0.25 m ( $\varnothing 0.5$  mm) with solder connection board  
 Pressure resistance (static): front 100 bar / rear side splash water  
 Max. operating temperature: 150 °C  
 Housing material: stainless steel and ceramic  
 Sensor cable: ECx/1, length  $\leq 6$  m



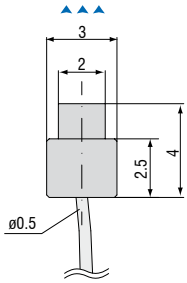

**EU05(10) Unshielded Sensor**  
 Measuring range 0.5 mm  
 Temperature stability  $\leq \pm 0.025\%$  FSO/ $^{\circ}\text{C}$   
 Connection: integrated coaxial cable 0.25 m ( $\varnothing$  0.5 mm) with solder connection board  
 Max. operating temperature: 150  $^{\circ}\text{C}$   
 Housing material: stainless steel and ceramic  
 Sensor cable: ECx/1, length  $\leq$  6 m

cable length 0.25 m  $\pm$  0.04 m

3:1

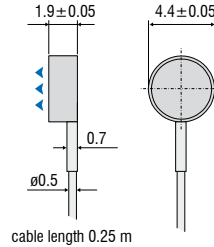

**ES05/180(16) Shielded Sensor**  
 Measuring range 0.5 mm  
 Temperature stability  $\leq \pm 0.025\%$  FSO/ $^{\circ}\text{C}$   
 Connection: integrated coaxial cable 0.25 m ( $\varnothing$  0.5 mm) with solder connection board  
 Max. operating temperature: 180  $^{\circ}\text{C}$   
 Housing material: stainless steel and epoxy  
 Sensor cable: ECx/1, length  $\leq$  6 m

3:1

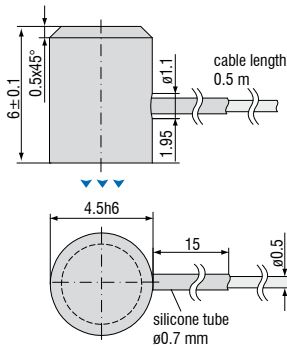

**ES05(36) Shielded Sensor**  
 Measuring range 0.5 mm  
 Connection: integrated coaxial cable 0.5 m ( $\varnothing$  0.5 mm) with solder connection board  
 Max. operating temperature: 150  $^{\circ}\text{C}$   
 Housing material: stainless steel and epoxy  
 Sensor cable: ECx/1, length  $\leq$  6 m

3:1

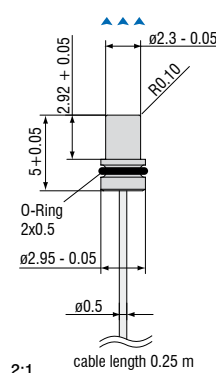

**EU05(65) Unshielded Sensor**  
 Measuring range 0.5 mm  
 Connection: integrated coaxial cable 0.25 m ( $\varnothing$  0.5 mm) with solder connection board  
 Pressure resistance (static): front 700 bar / rear side splash water  
 Max. operating temperature: 150  $^{\circ}\text{C}$   
 Housing material: ceramic  
 Sensor cable: ECx/1, length  $\leq$  6 m

2:1

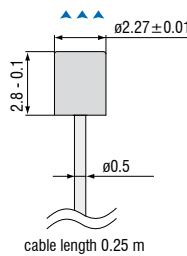

**EU05(66) Unshielded Sensor**  
 Measuring range 0.5 mm  
 Temperature stability  $\leq \pm 0.025\%$  FSO/ $^{\circ}\text{C}$   
 Connection: integrated coaxial cable 0.25 m ( $\varnothing$  0.5 mm) with solder connection board  
 Pressure resistance (static): front 400 bar / rear side splash water  
 Max. operating temperature: 150  $^{\circ}\text{C}$   
 Housing material: ceramic  
 Sensor cable: ECx/1, length  $\leq$  6 m

3:1

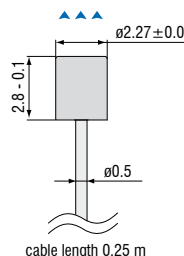

**EU05(72) Unshielded Sensor**  
 Measuring range 0.4 mm  
 Temperature stability  $\leq \pm 0.025\%$  FSO/ $^{\circ}\text{C}$   
 Connection: integrated coaxial cable 0.25 m ( $\varnothing$  0.5 mm) with solder connection board  
 Pressure resistance (static): front 2000 bar / rear side splash water  
 Max. operating temperature: 150  $^{\circ}\text{C}$   
 Housing material: ceramic  
 Sensor cable: ECx/1, length  $\leq$  6 m

3:1

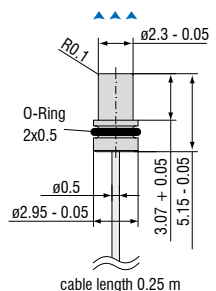

**EU05(93) Unshielded Sensor**  
 Measuring range 0.4 mm  
 Temperature stability  $\leq \pm 0.025\%$  FSO/ $^{\circ}\text{C}$   
 Connection: integrated coaxial cable 0.25 m ( $\varnothing$  0.5 mm) with solder connection board  
 Pressure resistance (static): front 2000bar / rear side splash water  
 Max. operating temperature: 150  $^{\circ}\text{C}$   
 Housing material: ceramic  
 Sensor cable: ECx/1, length  $\leq$  6 m

2:1

Article	Description	eddyNCDT 3001	eddyNCDT 3005	eddyNCDT 3060	eddyNCDT 3300
PCx/8-M12	Supply and signal cable, 8-pin, lengths: 3 / 5 / 10 / 15 m			•	
PCx/5-M12	Supply and signal cable, 5-pin, 5 m / 20 m	•	•		
SCD2/4/RJ45	Industrial Ethernet cable with M12 connector, 4-pin, 2 m			•	
PS2020	Power supply 24 V / 2.5 A, input 100 - 240 VAC, output 24 VDC / 2.5 A, mounting onto symmetrical standard rail 35 mm x 7.5 mm, DIN 50022;	•	•	•	•
SCAx/5	Signal cable, analog, 3 / 6 / 9 m				•
SCDx/8	Signal cable for switching inputs and outputs, 3 / 6 m (also for 11 - 32 VDC supply); for DT3301				•
PSCx	Supply and synchronization cable 0.3 / 1 m, for DT3300				•
ESCx	Synchronization cable 0.3 / 1 m, for DT3301				•

## High performance sensors made by Micro-Epsilon



Sensors and systems for displacement and position



Sensors and measurement devices for non-contact temperature measurement



2D/3D profile sensors (laser scanner)



Optical micrometers, fiber optic sensors and fiber optics



Color recognition sensors, LED analyzers and color online spectrometer



Measurement and inspection systems