



More Precision

induSENSOR // Linear inductive displacement sensors





- Proven LVDT technology
- Measuring ranges $\pm 1 \dots \pm 25 \text{ mm}$
- Extremely accurate also under difficult ambient conditions
- Long-term stability
- Wear-free measurement

LVDT displacement sensors have a plunger which moves freely in the sensor housing. The plunger is joined to the object by a thread to transfer the movement of the measurement object. The measurement process in the sensor takes place without contact and is therefore wear-free. The displacement sensors are mainly used to measure and monitor movements, displacements, positions, strokes, deflections, dislocations, etc. in vehicles, machines and systems.

The high sensor resolution is limited only by the noise in the sensor electronics. A further advantage of the symmetrically constructed sensors in the LVDT series is the zero point stability of the systems. The sensors are supplied with an excitation frequency of 1 to 5 kHz depending on the measuring range and an excitation amplitude of 2.5 to 5 V eff. Matched sensor electronics are available in this respect.

With appropriate setting possibilities for the excitation frequency and amplitude, the sensors can also be operated with alternative electronics.

Article designation

DT	A-	10-	D-	3-	CA-	W
Options (on request):						
W Welded sensor housing (water proof up to 5 bar)						
P Pressure-resistant sensors housing with tightness test (up to 100 bar)						
F Pressure-resistant mounting flange O-ring seal						
H High-temperature sensor models up to 200 °C with integral Teflon cable (only for sensor models with -CA/-CR connections)						
Axial connections			Radial connections			
CA integral cable (3 m)			CR integral cable (3 m)			
SA plug-in connection			SR plug-in connection			
Linearity: 5 ($\pm 0.5 \%$)		3 ($\pm 0.3 \%$)		1.5 ($\pm 0.15 \%$)		
Function: displacement sensor						
Measuring range in mm						
Excitation AC						
Principle: Differential Transformer (LVDT)						

Model	DTA-1D-		DTA-3D-		DTA-5D-		DTA-10D-		DTA-15D-				DTA-25D-			
	CA	SA	CA	SA	CA	SA	CA	SA	CA	CR	SA	SR	CA	CR	SA	SR
Connection	CA	SA	CA	SA	CA	SA	CA	SA	CA	CR	SA	SR	CA	CR	SA	SR
Measuring range	± 1 mm		± 3 mm		± 5 mm		± 10 mm		± 15 mm				± 25 mm			
Linearity	Standard ± 0.5 %		-	-	-	-	-	-	-				300 µm			
	Standard ± 0.3 %		6 µm	18 µm	30 µm	60 µm	90 µm	on request				on request				
	Option ± 0.15 %		3 µm	9 µm	15 µm	on request				-						
Excitation frequency	5 kHz				2 kHz				1 kHz							
Excitation amplitude	5 V _{eff}								2.5 V _{eff}							
Sensitivity	133 mV/Vmm		85 mV/Vmm		53 mV/Vmm		44 mV/Vmm		45 mV/Vmm				33 mV/Vmm			
Temperature range	-20 ... +80 °C ¹⁾															
Storage temperature	-40 ... +80 °C															
Temperature stability ³⁾	Zero								70 ppm/°C							
	Max. temp. error								150 ppm/°C							
Sensor housing	stainless steel including magnetic shielding															
Minimum cable bending radius	20 mm															
Outer diameter (cable)	~4.6 mm															
Protection class	IP 67 ²⁾															
Shock	40 g, 1000 shocks / axis															
	100 g, 3 shocks / direction															
Vibration	10 ... 58 Hz ± 1.5 mm / 58 ... 500 Hz ± 20 g															
Suitable controller	MSC7401 (pages 10 - 11)															

FSO = Full Scale Output

¹⁾ Higher temperatures on request

²⁾ Higher pressures on request

³⁾ Determined according to box method (-40 ... +80 °C)

Sensor types with measuring range up to ± 10mm (inner diameter 2.7 mm; plunger diameter 2 mm)

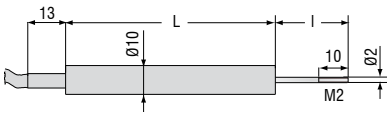

Type-CA with integral cable

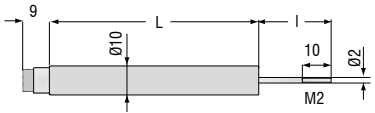

Type-SA with axial plug connection

Sensor types with measuring range ± 15mm and ± 25mm (inner diameter 4.8 mm; plunger diameter 4 mm)

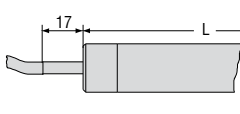

Type-CA with integral cable

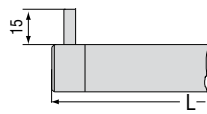

Type-CR with integral cable (radial)

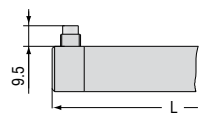

Type-SR with radial plug connection

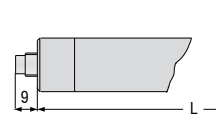

Type-SA with axial plug connection

Basic model	DTA-1D-		DTA-3D-		DTA-5D-		DTA-10D-		DTA-15D-				DTA-25D-			
Connection	CA	SA	CA	SA	CA	SA	CA	SA	CA	CR	SA	SR	CA	CR	SA	SR
Housing length L	40 mm	40 mm	57 mm	57 mm	73 mm	73 mm	87 mm	87 mm	106.5 mm				143.5 mm			
Plunger length l ¹⁾	19 mm		29 mm		30 mm		35 mm		51 mm				62 mm			
Housing diameter	10 mm								20 mm							

¹⁾ Plunger in zero position (±10% of measuring range ±1 mm)

Female connector 90°
dimensions apply for all models

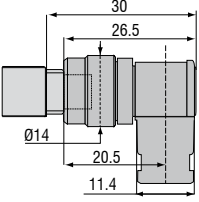

Female connector
dimensions apply for all models

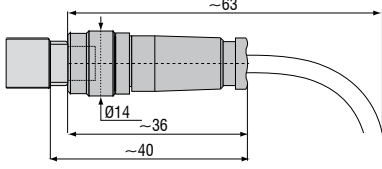

General accessories

2960031	MC25D	Digital micrometer calibration fixture
2420062	PS2020	Power supply on DIN rail, input 100 - 240 VAC, output 24 VDC / 2.5 A
2984026		Function and linearity inspection certificate incl. protocol with listed measurement data of the linearity inspection and documentation
2213034		IF7001 single-channel USB/RS485 converter

Accessories for LDR series**Connection cables**

0157047	C7210-5/3	Sensor cable, 5 m, with cable connector
0157048	C7210/90-5/3	Sensor cable, 5 m, with 90° cable connector

Supply cable

2901087	PC710-6/4	Supply/output cable, 6 m
---------	-----------	--------------------------

Spare plungers

0800136	LDR-10	Spare plunger
0800137	LDR-25	Spare plunger
0800138	LDR-50	Spare plunger

Service

Connector installation and adjustment

Accessories for EDS series**Service**

2985001		Function and linearity inspection for EDS series incl. pressure inspection and documentation without recalibration
---------	--	---

Connection cables

0157043	C703-5	VIP/LVP/EDS 7-pin connection cable for S series, 5 m
2902084	C703-5/U	VIP/LVP/EDS 7-pin connection cable for S series, 5 m for voltage output 1 - 5 V
0157050	C703/90-5	VIP/LVP/EDS 7-pin connection cable for S series, 5 m with 90° cable connector
2901143	C705-5	VIP/LVP/EDS 5-pin connection cable for F series, 5 m
2901160	C705-15	VIP/LVP/EDS 5-pin connection cable for F series, 15 m

Installation ring

0483326		EDS mounting ring
---------	--	-------------------

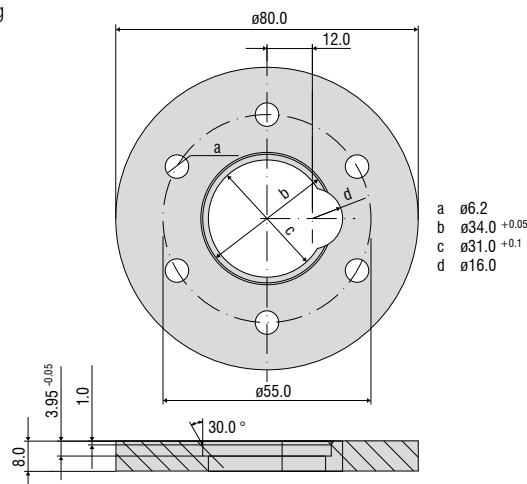

Linearity inspection certificate

Accessories for LVDT series

Sensor cables

2902004	C701-3	Sensor cable, 3 m, with cable connector and tin-plated free ends
2902013	C701-6	Sensor cable, 6 m, with cable connector and tin-plated free ends
2902009	C701/90-3	Sensor cable, 3 m, with 90° cable connector and tin-plated free ends
2213034	IF7001	Single-channel USB/RS485 converter for MSC7xxx

Service

2981010	Connector installation and calibration
---------	--

Connection cables

2901087	PC710-6/4	Supply/output cable, 6 m, open ends
29011154	PC5/5-IWT	Supply/output cable, 5 m, open ends/M12

Spare plungers

0800001	DTA-1D	Spare plunger
0800002	DTA-3D	Spare plunger
0800003	DTA-5D	Spare plunger
0800004	DTA-10D	Spare plunger
0800005	DTA-15D	Spare plunger
0800006	DTA-25D	Spare plunger

Flanges

0483090.01	DTA-F10	Mounting flange, slotted for DTA-1D, DTA-3D, DTA-5D, DTA-10D
0483083.02	DTA-F20	Mounting flange, slotted for DTA-15D, DTA-25D

Probe tips

0459002	Type 2
0459001	Type 2 (hard metal)
0459003	Type 11
0459004	Type 13

Flange DTA-F10

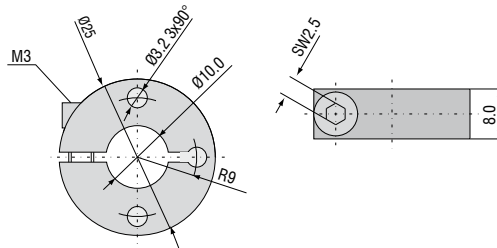

Flange DTA-F20

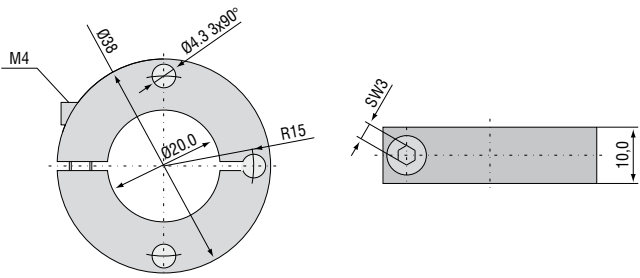

Standard probe tip: type 2

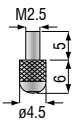

Option: type 11

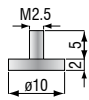

Option: type 13

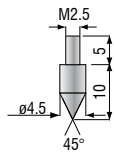

High performance sensors made by Micro-Epsilon



Sensors and systems for displacement and position



Sensors and measurement devices for non-contact temperature measurement



2D/3D profile sensors (laser scanner)



Optical micrometers, fiber optic sensors and fiber optics



Color recognition sensors, LED analyzers and color inline spectrometer



Measurement and inspection systems