

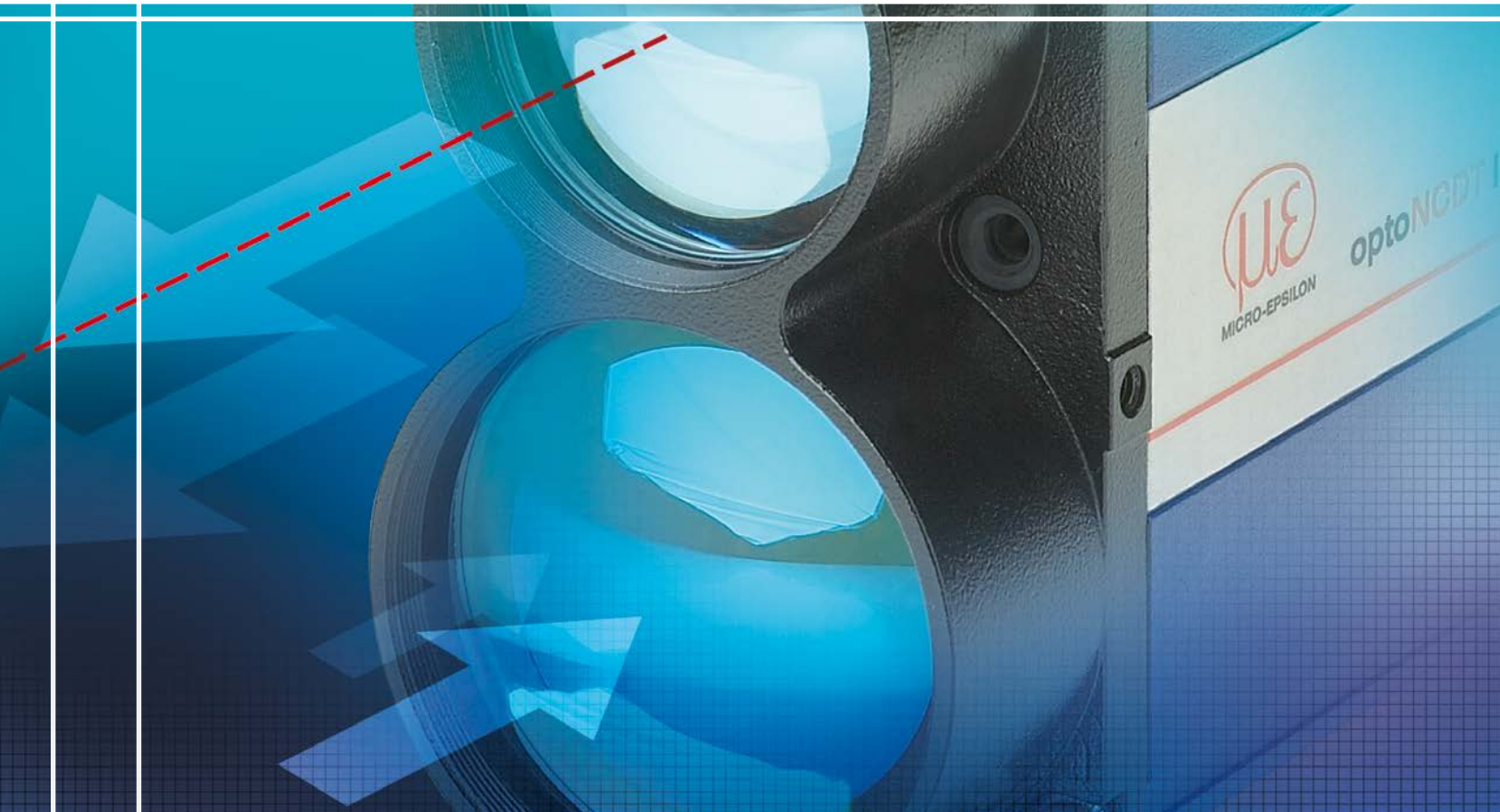

# More Precision

optoNCDT ILR // Laser distance sensors





- Measuring range up to 50 m on diffuse reflecting surfaces, up to 150 m with reflector plate
- Option with integral heating
- Easy alignment with laser sighting
- Precise measurement on various surfaces
- User-friendly sensor installation
- Accessories and special models available

optoNCDT ILR 1181/1182/1183 sensors are optoelectronic sensors for non-contact distance and displacement measurement for industrial applications. Both sensors operate according to the phase comparison principle, whereby higher precision can be achieved. They can be easily aligned and positioned with a visible laser beam.

The optoNCDT ILR 1182 series operates with a 50 Hz measuring rate and is therefore suitable for fast processes. The mounting grooves on the housing offer flexible mounting options for many situations.

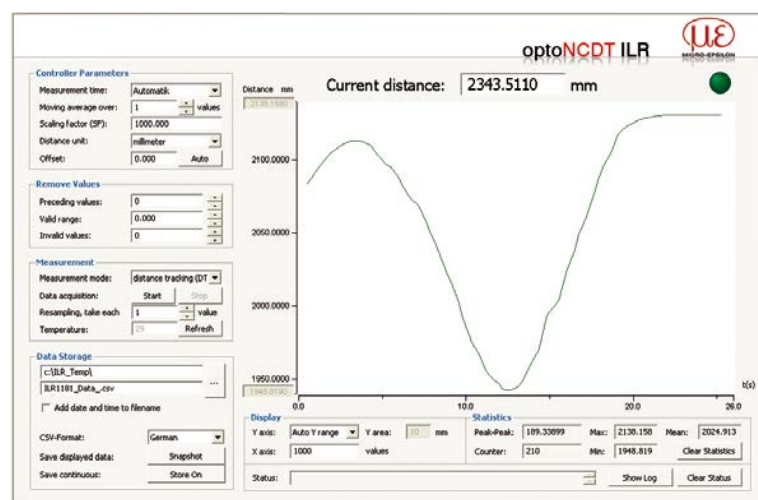
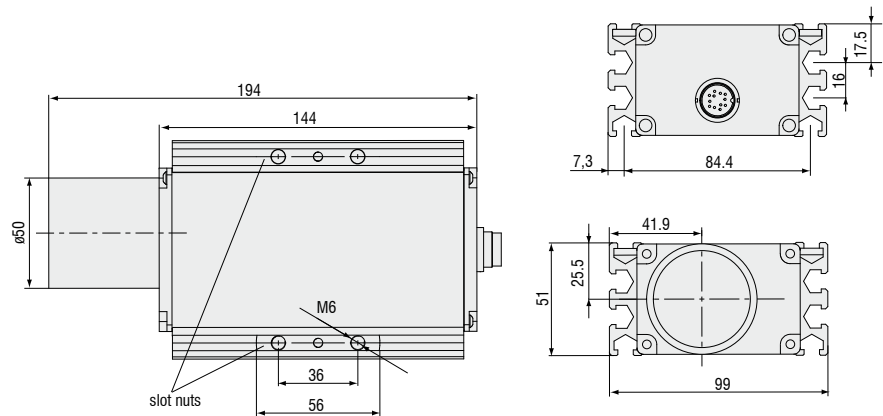

Configuration and measurement software for ILR1181 and ILR1182

Model	ILR1181-30	ILR1182-30	ILR1183-30
Article no.	7112007	7112008	7112009
Measuring range <sup>1)</sup>	black 6%	0.4 ... 17 m	
	gray 10%	0.1 ... 30 m	
	white 90%	0.1 ... 50 m	
	Reflector film	50 ... 150 m (reflective foil ILR-RF118x)	
Linearity <sup>2)</sup>	± 2 mm (+15 ... +30 °C), ± 5 mm (- 40 ... +50 °C)		
Resolution	0.1 mm		
Repeatability	≤ 0.5 mm		
Response time <sup>1)</sup>	100 ms ... 6 s	20 ms ... 6 s	20 ms ... 6 s
Light source	semiconductor laser (red 650 nm)		
Laser safety class	EN 60825-1:2014	class 2	
Operating temperature	-10 ... + 50 °C (optional -40 ... +50 °C, with integral heating)		
Storage temperature	-40 ... +70 °C		
Switching output	Q1 (max. 500 mA)	Q1 / Q2 (max. 500 mA)	
Switching points	freely adjustable		
Switching hysteresis	freely adjustable		
Trigger input (not with integral heating)	adjustable trigger edge and delay, trigger pulse max. 24 V		
Serial interface	RS232 or RS422 <sup>3)</sup> adjustable, max. 38.4 kBaud	SSI interface (RS422), 24Bit, gray-coded, 50kHz ... 1MHz	
Profibus <sup>3)</sup>	-	Profibus (RS485) 9.6 kBaud ... 12 MBaud <sup>3)</sup>	
Operating mode	individual measurement, external triggering, distance tracking, continuous measurement		
Analog output	4 ... 20 mA (16 Bit DA)	-	
Temperature stability	≤ 50 ppm / °C		
Supply	10 ... 30 VDC		
Max. power consumption	< 1.5 W at 24 V (< 24 W with heating)		< 3.2 W at 24 V (< 26 W with heating)
Connection	12-pin M16	1 x 12-pin M16 2 x 5-pin M12 B-encoded	
Protection class	IP65		
Housing material	aluminum strangeness profile, powder-coated		
Vibration/shock	500 g, 0.5 ms, 1 shock in each direction (DIN ISO 9022-30-08-1)		
	10 g, 6 ms, 1000 shocks in each direction (DIN ISO 9022-3-31-01-1)		
Weight	980 g		
EMC	complies with 2014/30/EU		
Accessories	page 10		

<sup>1)</sup> depending on target reflectance, ambient light influences and atmospheric conditions

<sup>2)</sup> with statistical spread of 95%

<sup>3)</sup> sensor configuration via interface

### Product identification

#### ILR 118x - 30 (x x)

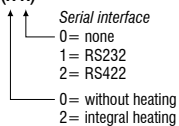

### Spot diameter ILR1181/1182/1183



optoNCDT ILR 1181/1182/1183 sensors operate with a wavelength of 650 nm (visible, red). Laser power is < 1 mW. The sensors fall within laser class 2. Laser class 2 devices require no special safety precautions.

## Accessories

## Supply and output cable ILR10xx

Art. No.	Description	
2901232	PC1000-2	Length 2 m
2901233	PC1000/90-2	Length 2 m, 90° connector
2901234	PC1000-5	Length 5 m
2901235	PC1000/90-5	Length 5 m, 90° connector
2901268	PC1000/90-10	Length 10 m, 90° connector

## Supply and output cable ILR11xx

Art. No.	Description	
2901524	PC1100-3	Length 3 m
2901239	PC1100/90-3	Length 3 m, 90° connector
2901573	PC1100-5	Length 5 m
2901235	PC1100/90-5	Length 5m, 90° connector
2901236	PC1100/10	Length 10 m
2901241	PC1100/90-10	Length 10 m, 90° connector
2901237	PC1100/20	Length 20 m
2901242	PC1100/90-20	Length 20 m, 90° connector
2901238	PC1100/30	Length 30 m
2901243	PC1100/90-30	Length 30 m, 90° connector
0323241	FC1100	Cable connector
0323242	FC1100/90	Cable connector, 90° (angled)
2901551	PC1100/90-3/RS232	Length 3 m, 90° connector, RS232

## Profibus

Art. No.	Description	
2901435	PBC1100-I/O-5	Profibus input and output cable, 5 m
2901436	PBC1100-I-5	Profibus input cable, 5 m
2901437	PBC1100-I-10	Profibus input cable, 10 m
2901438	PBC1100-O-5	Profibus output cable, 5 m
2901439	PBC1100-O-10	Profibus output cable, 10 m
0323310	PBFC1100	Profibus socket
0323311	PBMC1100	Profibus plug
0323312	PBLR1100	Profibus terminating resistor

## Accessories for ILR10xx series

Art. No.	Description	
7966001	ILR-RF250	Reflector film 250 x 250 mm
7966002	ILR-R250	Reflector 250 x 250 mm

## Accessories for ILR 118x / 1191 series

Art. No.	Description	
7966014	ILR-MP1191	Mounting plate for ILR1191
7966015	ILR-AA1191	Aligning aid for ILR1191
7966016	ILR-PT1191	Protection tube, 100 mm for ILR1191
7966019	ILR-RF118x	Reflector film 250 x 250 mm for ILR1181X
7966020	ILR-MT118x	Mounting clamp for ILR118x
7966025	ILR-MP118x	Mounting plate for ILR118x
7966021	ILR-MTN118x	Slot nuts for ILR118x
7966022	ILR-FBV118x	Air purge collar for ILR118x
7966023	ILR-PG118x	Protective glass for ILR118x
7966024	ILR-FV118x	Filter adapter for ILR118x
2213025	IF2001/USB	RS422/USB converter

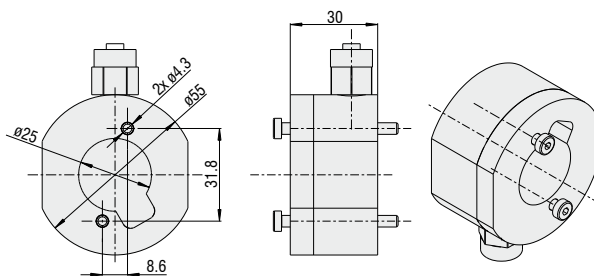

ILR-FBV118x air purge collar for ILR118x

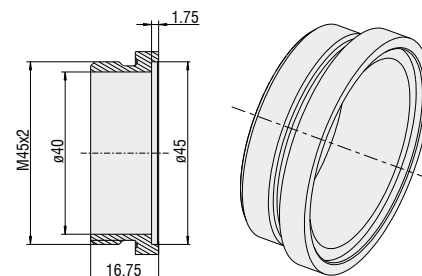

ILR-PG118x protection glass for ILR118x



**Free setup and configuration software**

The scope of supply includes software for easy sensor configuration. The settings can be implemented conveniently via a Windows user interface on the PC. The sensor parameters are transmitted to the sensor via the serial port and can also be saved if required. The software also contains a module which can display and store the measurement results. The sensor is connected to the PC via the sensor cable using a USB converter.

**Free download**

Download free of charge from [www.micro-epsilon.com/download](http://www.micro-epsilon.com/download): software and driver for easy sensor integration in existing software.

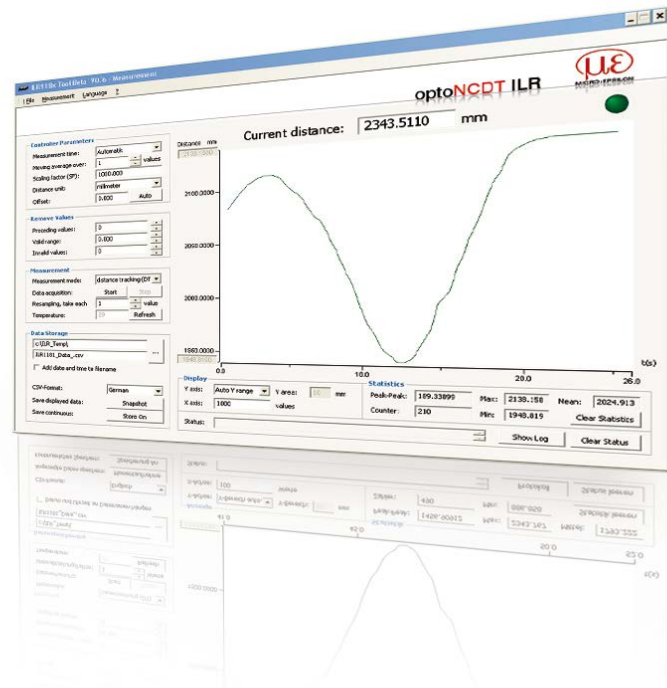

**Applications**



**Position measurement on gantry cranes**

Numerous measurement tasks on gantry cranes must be performed: Positioning of the trolley, detection and dimensioning of containers and monitoring of the minimum clearance between the cranes. The ILR1191 with a very large measuring range and low response time is designed for these measurement tasks.

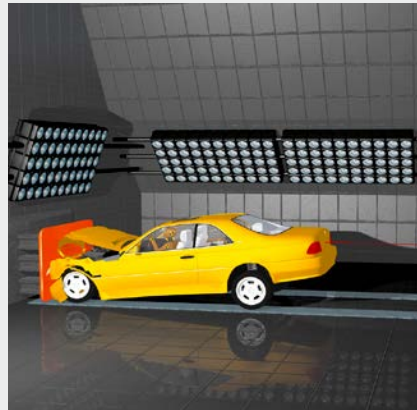

**Crash test speed measurement**

At acceleration of cars during crash tests, an ILR1191 measures the impact speed and deformation of the test vehicle.

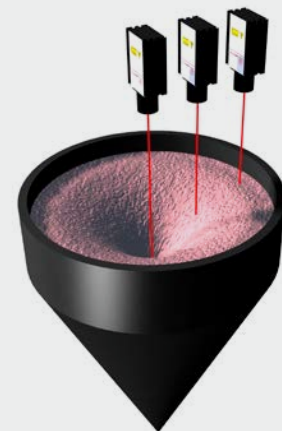

**Filling level measurement in silos**

Depending on the required accuracy, laser distance sensors determine the filling level of silos at up to four points. Based on these distances, the filling level is calculated.

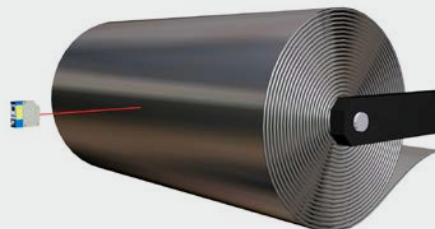

**Acquisition of coil diameters**

The quantity of steel wound on and off is monitored via the acquisition of coil diameters using laser probes.

## Sensors and Systems from Micro-Epsilon



Sensors and systems for displacement, distance and position



Sensors and measurement devices for non-contact temperature measurement



Measuring and inspection systems for metal strips, plastics and rubber



Optical micrometers and fiber optics, measuring and test amplifiers



Color recognition sensors, LED analyzers and inline color spectrometers

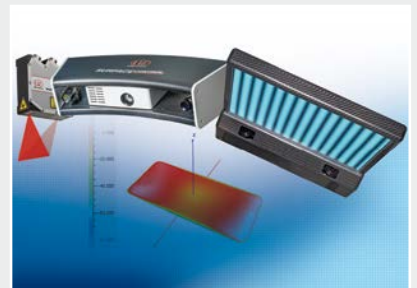

3D measurement technology for dimensional testing and surface inspection