









# More Precision

**optoNCDT** // Laser displacement sensors (triangulation)





-  **Ideal for serial and OEM applications**
-  **Compact design with integrated controller**
-  **Measuring rate up to 4 kHz**  
312Hz  
375Hz  
1000Hz
-  **Analog (U/I) and digital output**
-  **Trigger input / teach-in zero-setting / mastering**
-  **Configuration via web interface or Plug & Play**
-  **Application-specific presets and individual setups**
- ATC** **Auto Target Compensation**

The optoNCDT 1420 offers a unique combination of speed, size, performance and application versatility in the range of compact triangulation sensors. The sensor with integrated controller is used in restricted installation space or dynamic applications. The selectable connector type, i.e. cable or pigtail, together with compact size reduce the sensor installation effort to a minimum. The Auto Target Compensation (ATC) provides stable distance signal control. The high-performance optical system projects the small light spot sharply onto the measurement object which enables to even detect smallest components and every little detail reliably.

**Highest precision in a minimum of space**

Compact size combined with low weight opens up new fields of application. Analog and digital output signals enable to integrate the sensor into plant or machine control systems. The triangulation sensor achieves a high measurement accuracy with measuring rates of up to 4 kHz.

**Unique ease of use, individual results**

All optoNCDT 1420 models are operated using an extended web interface. The settings for the measurement task can be quickly selected using predefined presets.

The quality slider enables the sensor to be adapted to static and dynamic processes.

Up to eight user-specific sensors settings can be stored and exported in the setup management. The video signal display, the signal peak selection and a freely adjustable signal averaging enable to optimize the measurement task.

The ROI function (region of interest) allows e.g. for interfering signals in the background to be filtered out. The remaining signal peak is optimally corrected.

MR	SMR	Y
10	20	10
25	25	21
50	35	28
100	50	46
200	60	70
500	100	90

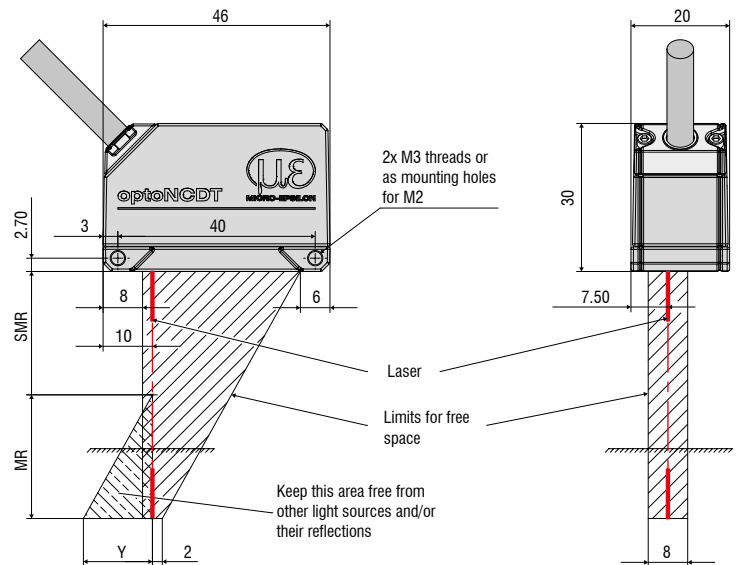

Model	ILD1420-10	ILD1420-25	ILD1420-50	ILD1420-100	ILD1420-200	ILD1420-500	
Measuring range	10 mm	25 mm	50 mm	100 mm	200 mm	500 mm	
Start of measuring range SMR	20 mm	25 mm	35 mm	50 mm	60 mm	100 mm	
Midrange MMR	25 mm	37.5 mm	60 mm	100 mm	160 mm	350 mm	
End of measuring range EMR	30 mm	50 mm	85 mm	150 mm	260 mm	600 mm	
Linearity <sup>1)</sup>	≤ 8 ... ≤ 10 μm	≤ 20 ... ≤ 25 μm	≤ 40 ... ≤ 50 μm	≤ 80 ... ≤ 100 μm	≤ 160 ... ≤ 200 μm	≤ 500 ... ≤ 1000 μm	
	≤ 0.08 ... ≤ 0.1 % FSO					≤ 0.1 ... ≤ 0.2 % FSO	
Repeatability <sup>2)</sup>	0.5 μm	1 μm	2 μm	4 μm	8 μm	20 ... 40 μm	
Measuring rate <sup>3)</sup>	0.25 kHz / 0.5 kHz / 1 kHz / 2 kHz / 4 kHz						
Light source	semiconductor laser <1 mW, 670 nm (red)						
Permissible ambient light	10,000 lx						
Spot diameter ± 10 %	SMR	90 x 120 μm	100 x 140 μm	90 x 120 μm	750 x 1100 μm	750 x 1100 μm	750 x 1100 μm
	MMR	45 x 40 μm	120 x 130 μm	230 x 240 μm			
	EMR	140 x 160 μm	390 x 500 μm	630 x 820 μm	-	-	-
	smallest diameter	45 x 40 μm with 24 mm	55 x 50 μm with 31 mm	70 x 65 μm with 42 mm			
Protection class	IP65						
Laser safety class	Class 2 in accordance with DIN EN 60825-1 : 2008-05						
Temperature stability	± 0.03 % FSO/°C						
Operating temperature	0 ... +50 °C (non-condensing)						
Storage temperature	-20 ... +70 °C (non-condensing)						
Control inputs/outputs	1x HTL Multifunction input Trigger in / zero setting / mastering / teach (1x error output npn, pnp, push pull)						
Measurement value output	analog	4 ... 20 mA (1... 5 V with cable PCF1420-3/U); 12 bit; freely scalable within the measuring range <sup>4)</sup>					
	digital	RS422 / 16bit					
Vibration	20 g / 20 ... 500 Hz (in accordance with IEC 60068-2-6)						
Shock	15 g / 6 ms / 3 axes (according to IEC 60068-2-29)						
Weight	with 3 m cable	approx. 145 g					
	with pigtail	approx. 60 g					
Displays	2 x 3 color LEDs for power and status						
Operation	button	select button for zero / teach / factory settings					
	web interface	application-specific presets; peak selection, video signal; freely selectable averaging possibilities; data reduction; setup management <sup>5)</sup>					
Supply voltage	11 ... 30 VDC						
Power consumption	< 2 W (24 V)						
Sensor cable	3m integrated, open ends						
	0.3m pigtail with 12-pole M12 connector						
Electronics	integrated signal processor						
Electromagnetic compatibility (EMC)	EN 61 000-6-3 / DIN EN 61326-1 (Class B) EN 61 000-6-2 / DIN EN 61326-1						

FSO = Full Scale Output; The specified data apply to a white, diffuse reflecting surface (reference: ceramics);

SMR = start of measuring range; MMR = midrange; EMR = end of measuring range

<sup>1)</sup> Values apply from 0 - 50 % FSO or 50 - 100 % FSO; <sup>2)</sup> measuring rate: 2kHz, median 9;

<sup>3)</sup> Factory setting 2 kHz; modifying the factory settings requires the IF2001/USB converter (optionally available)

<sup>4)</sup> The d/a conversion is executed with 12 Bit; <sup>5)</sup> Connection to PC via IF2001/USB (optionally available)

**Accessories for all optoNCDT Series****Power supply**

- PS 2020 (power supply 24 V / 2.5 A, input 100 - 240 V AC, output 24 VDC / 2.5 A, mounting onto symmetrical standard rail 35 mm x 7.5 mm, DIN 50022)

**Controller unit for evaluation and signal conversion**

- C-Box/2A (controller for conversion and evaluation of up to 2 sensor signals)

**Interface card**

- IF2008 (interface card for multiple signal processing; analog and digital interfaces)

**USB converter**

- IF2001/USB RS422/USB converter (converter for digital signals in USB)

**USB converter**

- IF2004/USB 4-channel RS422/USB converter (converter for up to 4 digital signals in USB)

**Accessories for optoNCDT 1320 / 1420 / 1402CL1****Supply and output cable (drag-chain suitable)**

- PCF1420-1/I (1 m, output 4...20 mA)
- PCF1420-1/I(01) (1 m, output 4...20 mA)
- PCF1420-3/I (3 m, output 4...20 mA)
- PCF1420-6/I (6 m, output 4...20 mA)
- PCF1420-10/I (10 m, output 4...20 mA)
- PCF1420-15/I (15 m, output 4...20 mA)
- PCF1420-3/U (3 m, with integrated resistor, output 1...5 VDC)\*
- PCF1420-6/U (6 m, with integrated resistor, output 1...5V DC)\*
- PCF1420-10/U (10 m, with integrated resistor, output 1...5 VDC)\*
- PCF1420-15/U (15 m, with integrated resistor, output 1...5 VDC)\*
- PCF1420-3/IF2008 (3 m, interface and supply cable)
- PC1420-6/IF2008 (6 m, supply and output cable)
- PCF1420-10/IF2008 (10 m, interface and supply cable)

\* on request with output 2...10 VDC

**Supply and output cable, suitable for use with robots**

(available in 90° version)

- PCR 1402-3/I (3 m)
- PCR 1402-6/I (6 m)
- PCR 1402-8/I (8 m)

**Accessories for optoNCDT 1610 / 1630****Supply and output cable**

- PC 1605-3 (3 m)
- PC 1605-6 (6 m)
- PC 1607-5/BNC (5 m, BNC connector)

**Accessories for optoNCDT 1750 / 1750LL / 1700BL****Supply and output cable (drag-chain suitable)**

- PC 1700-3 (3 m)
- PC 1700-10 (10 m)
- PC 1700-10/IF2008 (10 m, for use with interface card IF2008)
- PC 1700-3/T (3 m, for use with trigger box)
- PC 1700-10/T (10 m, for use with trigger box)
- PC 1700-3/USB (3 m, with USB-RS422-converter, power supply 90 ... 230 V AC)

**Supply and output cable (suitable for use with robots)**

- PCR 1700-5 (5 m)
- PCR 1700-10 (10 m)

**Supply and output cables for temperatures up to 200 °C**

- PC1700-3/OE/HT (3 m)
- PC1700-6/OE/HT (6 m)
- PC1700-15/OE/HT (15 m)

**Protection housing**

- SGH model (sizes S and M)
- SGHF model (sizes S and M)
- SGHF-HT model

**Accessories for optoNCDT 2300 / 2300LL / 2300BL****Supply and output cable**

- PC2300-0,5Y (connection cable to PC or PLC; for operation a PC2300-3/SUB-D will be required)
- PC2300-3/SUB-D (3 m; for operation a PC2300-0,5Y will be required)
- PC 2300-3/IF2008 (interface and supply cable)
- PC 2300-3/OE (3 m)
- PC 2300-6/OE (6 m)
- PC 2300-9/OE (9 m)
- PC 2300-15/OE (15 m)

\* other cable lengths on request

**Protection housing**

- SGH model (sizes S and M)
- SGHF model (sizes S and M)
- SGHF-HT model

**Supply and output cables for temperatures up to 200 °C**

- PC2300-3/OE/HT (3 m)
- PC2300-6/OE/HT (6 m)
- PC2300-9/OE/HT (9 m)
- PC2300-15/OE/HT (15 m)



### optoNCDT Demo Tool

The scope of supply includes a software for easy sensor configuration. The settings can be implemented conveniently via a Windows user interface on the PC. The sensor parameters are sent to the sensor via the serial port and can also be saved if required. The software is available as single and multi-channel version. The sensor is connected to the PC via the sensor cable using a USB converter.

[for any ILD sensor]

### Free download

Download free of charge from [www.micro-epsilon.com/download](http://www.micro-epsilon.com/download): software, driver and well-documented driver DLL for easy sensor integration in existing or customer software.

### Protection housing for harsh environment

To protect the laser sensors in extreme environments, individual protective housings are available for all sensor models. There are three different models:

#### SGH model:

Completely enclosed housing with an integrated front window, where the sensor measures through the window. The water-resistant housing provides protection against solvents and detergents.

#### SGHF model:

With window and compressed-air connection ideal for high ambient temperatures. The integrated air cooling of the housing offers optimum protection for the sensor.

#### SGHF-HT model

This water-cooled protection housing with window and compressed-air connection is designed for measurement tasks in ambient temperatures up to 200 °C.

Suitable for all long-range sensors

optoNCDT 1710

optoNCDT 1750-500 and optoNCDT 1750-750

optoNCDT 2310

optoNCDT 2300 - 200

Maximum ambient temperature 200 °C

Maximum cooling water temperature  $T(\max) = 10\text{ °C}$

Minimum water flow rate  $Q(\min) = 3\text{ liters/min}$



**SGHx ILD size S (140x140x71mm)**  
for optoNCDT 1750 / 2300 dimensions 97 x 75 mm

**SGHx ILD size M (140x180x71mm)**  
for optoNCDT 1750 / 2300 dimensions 150 x 80 mm



### IF2008 - PCI interface card

The IF2008 interface card is designed for installation in PCs and enables the synchronous capture of four digital sensor signals and two encoders. The IF2008E expansion board enables the acquisition of two digital sensor signals, two analog sensor signals and eight I/O signals. The absolutely synchronous data acquisition plays an important role particularly for planarity or thickness measurement tasks. The data are stored in a FIFO memory in order to enable resource-saving processing in the PC in blocks.

#### Special features

- 4x digital signals and 2x encoders with IF2008 basic PCB
- 2x digital signals, 2x analog signals and 8x I/O signals with IF2008E expansion board
- Additional expansion board for a total of 6x digital signals, 2x encoders, 2x analog signals and 8x I/O signals
- FIFO data memory
- Synchronous data acquisition

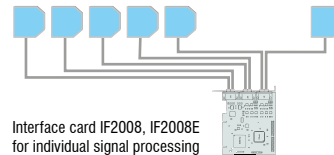

### IF2001/USB converter RS422 to USB

The RS422/USB converter transforms digital signals from a laser-optical sensor into a USB data packet. The sensor and the converter are connected via the RS422 interface of the converter. Data output is done via USB interface. The converter loops through further signals and features such as laser on/off, switch signals and function output. The connected sensors and the converter can be programmed through software.



**IF2004/USB: 4-channel converter from RS422 to USB**

The RS422/USB converter is used for transforming digital signals from up to four optical sensors into USB data signals. The converter has four trigger inputs and a trigger output for connecting additional converters. Data is output via an USB interface. The connected sensors and the converter can be programmed through software.

**Special features**

- 4x digital signals via RS422
- 4x trigger inputs, 1x trigger output
- Synchronous data acquisition
- Data output via USB



**C-Box/2A controller for conversion and evaluation of up to two sensor signals**

C-Box/2A is used for fast D/A conversion of two digital input signals or for evaluating two digital sensor signals. The controller is compatible with the optoNCDT 2300 laser triangulation sensors. Output of the sensor signals is possible via two configurable analog outputs, Ethernet or USB. Handling of the C-Box/2A and of the connected sensors are performed via web interface. Averaging functions, thickness, diameter, step and inclinations can be calculated. The D/A conversion is executed at 16Bit and max. 70kHz.



## High performance sensors made by Micro-Epsilon



Sensors and systems for displacement and position



Sensors and measurement devices for non-contact temperature measurement



2D/3D profile sensors (laser scanner)



Optical micrometers, fiber optic sensors and fiber optics



Color recognition sensors, LED analyzers and color inline spectrometer



Measurement and inspection systems