











More Precision

optoNCDT // Laser displacement sensors (triangulation)





-  **Two models with measuring ranges from 50 mm and 1000 mm**
-  **Blue Laser Technology (Blue violet laser diode 405 nm)**
-  **Real Time Surface Compensation**
-  **Adjustable measuring rate up to 2.5 kHz**
-  **Analog (U/I) and digital output**
-  **Adjustable filter functions**
-  **High flex cables for dragchain or robot use**
-  **Calibration certificate included**

Equipped with a blue-violet laser diode (405 nm), the optoNCDT 1710BL sensor achieves high accuracies on red-hot glowing metals and organic materials.

In numerous applications, Blue Laser sensors are superior to standard sensors that use a red laser diode. In contrast to a red laser, the reduced wavelength of the blue laser light does not penetrate materials such as wood, skin and foods. The blue laser generates a minimal laser point on the surface and therefore offers more stable, precise measurements.

The inner workings of the Blue Laser triangulation sensor are a complete re-design. The sensors are equipped with new high-end lenses, new intelligent laser control and evaluation algorithms.

optoNCDT 1710 (50/1000 mm)

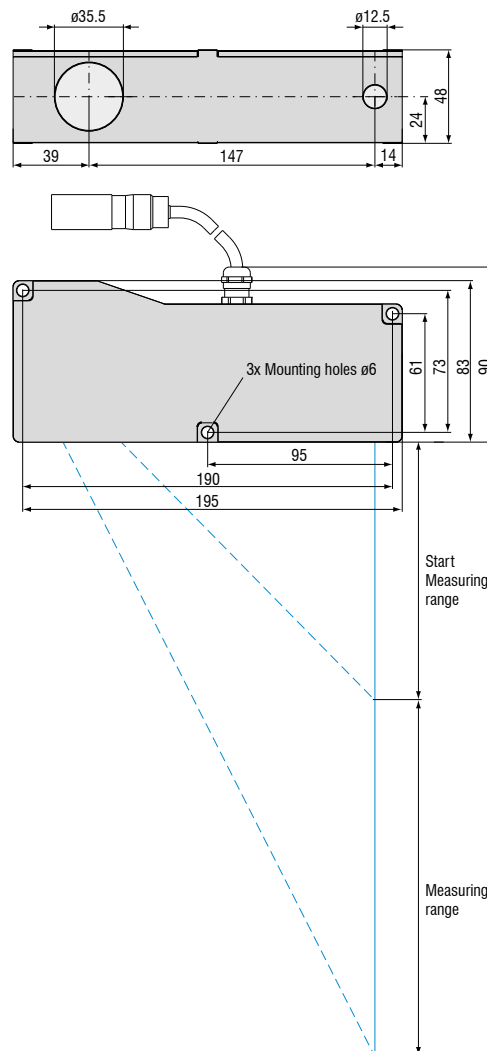

Model	ILD1710-50BL	ILD1710-1000BL	
Measuring range	50 mm	1000 mm	
Start of measuring range	550 mm	1000 mm	
Mid of measuring range	575 mm	1500 mm	
End of measuring range	600 mm	2000 mm	
Linearity	$\leq \pm 50 \mu\text{m}$	$\leq \pm 1 \text{ mm}$	
	$\leq \pm 0.1\% \text{ FSO}$	$\leq \pm 0.1\% \text{ FSO}$	
Resolution (at 2.5 kHz without averaging)	5 μm	100 μm	
Measuring rate	2.5 kHz / 1.25 kHz / 625 Hz / 312.5 Hz (adjustable)		
Light source	Semiconductor laser <1 mW, 405nm (blue violet), laser class 2		
Permissible ambient light (with 2.5 kHz)	10,000 lx		
Laser safety class	Class 2 in accordance with DIN EN 60825-1 : 2008-05		
Spot diameter	SMR	400 x 500 μm	2.5...5 mm
	MMR	400 x 500 μm	2.5...5 mm
	EMR	400 x 500 μm	2.5...5 mm
Temperature stability ¹⁾	0.01% FSO/°C		
Operating temperature	0 ... +50 °C		
Storage temperature	-20 ... +70 °C		
Output	Measured values	switchable: 4 ... 20 mA / 0 ... 10 V / RS422 / USB (optional via cable PC1700-3/USB)	
	Switching outputs	1 x error or 2x limit values (configurable)	
Switching input	Laser ON-OFF / Zero		
Operation	via membrane keypad on sensor or via PC with ILD 1700 tool		
Supply voltage	11 ... 30 VDC		
Max. current consumption	150 mA (24 V)		
Sensor cable (with connector)	standard 0.25 m integrated / option: 3 m or 10 m extensions		
Synchronization	possible for simultaneous or alternating measurements		
Protection class	IP65		
Vibration	2 g / 20 ... 500 Hz		
Shock	15 g / 6 ms		
Weight (with 25 cm cable)	approx. 800 g	approx. 800 g	

FSO = Full Scale Output; The specified data apply to a white, diffuse reflecting surface (reference: ceramics)

¹⁾ Based on digital output

SMR = start of measuring range; MMR = midrange; EMR = end of measuring range

Accessories for all optoNCDT Series**Power supply**

- PS 2020 (power supply 24 V / 2.5 A, input 100 - 240 VAC, output 24 VDC / 2.5 A, mounting onto symmetrical standard rail 35 mm x 7.5 mm, DIN 50022)

Controller unit for evaluation and signal conversion

- C-Box/2A (controller for conversion and evaluation of up to 2 sensor signals)

Interface card

- IF2008PCI / IF2008PCle (interface card for multiple signal processing; analog and digital interfaces)

USB converter

- IF2001/USB RS422/USB converter (converter for digital signals in USB)

USB converter

- IF2004/USB 4-channel RS422/USB converter (converter for up to 4 digital signals in USB)

Accessories for optoNCDT 1320 / 1420 / 1402CL1**Supply and output cable (drag-chain suitable)**

- PCF1420-1/I (1 m, output 4 ... 20 mA)
- PCF1420-1/I(O1) (1 m, output 4...20 mA)
- PCF1420-3/I (3 m, output 4 ... 20 mA)
- PCF1420-6/I (6 m, output 4 ... 20 mA)
- PCF1420-10/I (10 m, output 4 ... 20 mA)
- PCF1420-15/I (15 m, output 4 ... 20 mA)
- PCF1420-3/U (3 m, with integrated resistor, output 1 ... 5 VDC)*
- PCF1420-6/U (6 m, with integrated resistor, output 1 ... 5 VDC)*
- PCF1420-10/U (10 m, with integrated resistor, output 1 ... 5 VDC)*
- PCF1420-15/U (15 m, with integrated resistor, output 1 ... 5 VDC)*
- PCF1420-3/IF2008 (3 m, interface and supply cable)
- PCF1420-6/IF2008 (6 m, interface and supply cable)
- PCF1420-10/IF2008 (10 m, interface and supply cable)
- PCF1420-3/C-Box (3 m)

* on request with output 2 ... 10 VDC

Supply and output cable, suitable for use with robots

(available in 90° version)

- PCR 1402-3/I (3 m)
- PCR 1402-6/I (6 m)
- PCR 1402-8/I (8 m)

Accessories for optoNCDT 1610/1630**Supply and output cable**

- PC1605-3 (3 m)
- PC1605-6 (6 m)
- PC1607-5/BNC (5 m, BNC connector)

Accessories for optoNCDT**1750/1750LL/1750BL/1750DR/ 1710/1710BL****Supply and output cable (drag-chain suitable)**

- PC1700-3 (3 m)
- PC1700-10 (10 m)
- PC1700-10/IF2008 (10 m, for use with interface card IF2008)
- PC1750-3/C-Box (3 m)
- PC1750-6/C-Box (6 m)
- PC1750-9/C-Box (9 m)

Supply and output cable (suitable for use with robots)

- PCR1700-5 (5 m)
- PCR1700-10 (10 m)

Supply and output cables for temperatures up to 200 °C

- PC1700-3/OE/HT (3 m)
- PC1700-6/OE/HT (6 m)
- PC1700-15/OE/HT (15 m)

Protection housing

- SGH model (sizes S and M)
- SGHF model (sizes S and M)
- SGHF-HT model

Accessories for optoNCDT**2300 / 2300LL / 2300BL / 2300-2DR****Supply and output cable**

- PC2300-0,5Y (connection cable to PC or PLC; for operation a PC2300-3/SUB-D will be required)
- PC2300-3/SUB-D (3 m; for operation a PC2300-0,5Y will be required)
- PC2300-3/IF2008 (interface and supply cable)
- PC2300-3/OE (3 m)
- PC2300-6/OE (6 m)
- PC2300-9/OE (9 m)
- PC2300-15/OE (15 m)
- PC2300-3/C-Box/RJ45 (3 m)

* other cable lengths on request

Protection housing

- SGH model (sizes S and M)
- SGHF model (sizes S and M)
- SGHF-HT model

Supply and output cables for temperatures up to 200 °C

- PC2300-3/OE/HT (3 m)
- PC2300-6/OE/HT (6 m)
- PC2300-9/OE/HT (9 m)
- PC2300-15/OE/HT (15 m)

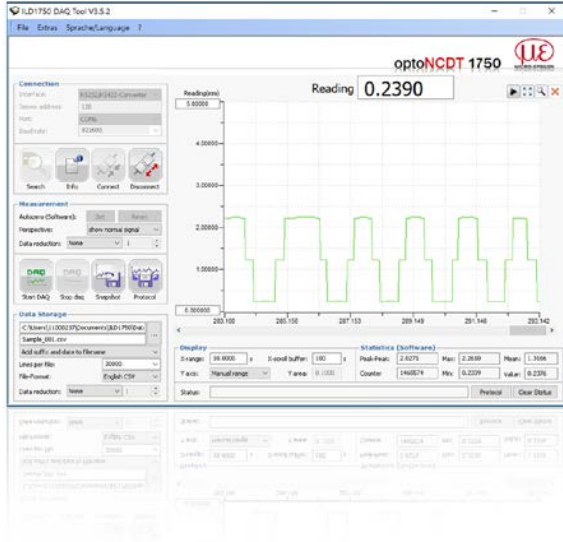

Protection housing for harsh environments

To protect the laser sensors in extreme environments, individual protective housings are available for all sensor models. There are three different models:

SGH model:

Completely enclosed housing with an integrated front window, where the sensor measures through the window. The water-resistant housing provides protection against solvents and detergents.

SGHF model:

With window and compressed-air connection ideal for high ambient temperatures. The integrated air cooling of the housing offers optimum protection for the sensor.

SGHF-HT model

This water-cooled protection housing with window and compressed-air connection is designed for measurement tasks in ambient temperatures up to 200 °C.

Suitable for all long-range sensors

optoNCDT 1710

optoNCDT 1750-500 and optoNCDT 1750-750

optoNCDT 2310

optoNCDT 2300 - 200

Maximum ambient temperature 200 °C

Maximum temperature of cooling water $T(\max) = 10\text{ °C}$

Minimum water flow rate $Q(\min) = 3\text{ liters/min}$

optoNCDT Demo Tool

The scope of supply includes a software for easy sensor configuration. The settings can be implemented conveniently via a Windows user interface on the PC. The sensor parameters are transmitted to the sensor via the serial port and can also be saved if required. The software is available as single and multi-channel version. The sensor is connected to the PC via the sensor cable using a USB converter. [for any ILD sensor]

Free download

Download free of charge from www.micro-epsilon.com/download: software, driver and well-documented driver DLL for easy sensor integration in existing or customer software.



SGHx ILD size S (140x140x71 mm)
for optoNCDT 1750 / 2300 dimensions 97x75 mm

SGHx ILD size M (140x180x71 mm)
for optoNCDT 1750 / 2300 dimensions 150x80 mm



IF2008PCI/IF2008 PCIe - PCI Interface card

The IF2008 interface card is designed for installation in PCs and enables the synchronous capture of four digital sensor signals and two encoders. The IF2008E expansion board enables the acquisition of two digital sensor signals, two analog sensor signals and eight I/O signals. The absolutely synchronous data acquisition plays an important role particularly for planarity or thickness measurement tasks. The data are stored in a FIFO memory in order to enable resource-saving processing in blocks in the PC.

Special features

- 4x digital signals and 2x encoders with IF2008 basic PCB
- 2x digital signals, 2x analog signals and 8x I/O signals with IF2008E expansion board
- 6x digital signals, 2x encoders, 2x analog signals and 8x I/O signals together with IF2008E
- FIFO data memory
- Synchronous data acquisition

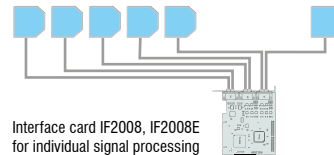
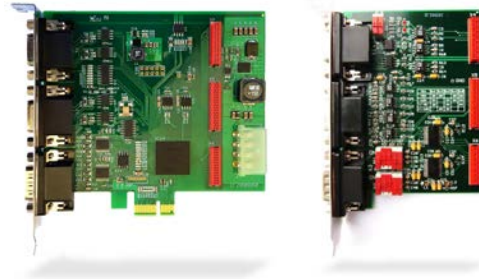

IF2001/USB converter RS422 to USB

The RS422/USB converter transforms digital signals from a laser-optical sensor into a USB data packet. The sensor and the converter are connected via the RS422 interface of the converter. Data output is done via USB interface. The converter loops through further signals and functions such as laser on/off, switch signals and function output. The connected sensors and the converter can be programmed through software.



IF2004/USB: 4-channel converter from RS422 to USB

The RS422/USB converter is used for transforming digital signals from up to four optical sensors into USB data signals. The converter has four trigger inputs and a trigger output for connecting additional converters. Data is output via an USB interface. The connected sensors and the converter can be programmed through software.

Special features

- 4x digital signals via RS422
- 4x trigger inputs, 1x trigger output
- Synchronous data acquisition
- Data output via USB



C-Box/2A Controller for conversion and evaluation of up to two sensor signals

C-Box/2A is used for fast D/A conversion of two digital input signals or for evaluating two digital sensor signals. The controller is compatible with the optoNCDT 2300 laser triangulation sensors. Output of the sensor signals is possible via two configurable analog outputs, Ethernet or USB. Handling of the C-Box/2A and of the connected sensors are performed via web interface. Averaging functions, thickness, diameter, step and inclinations can be calculated. The D/A conversion is executed at 16 bit and max. 70 kHz.



Sensors and Systems from Micro-Epsilon



Sensors and systems for displacement, distance and position



Sensors and measurement devices for non-contact temperature measurement



Measuring and inspection systems for metal strips, plastics and rubber



Optical micrometers and fiber optics, measuring and test amplifiers



Color recognition sensors, LED analyzers and inline color spectrometers

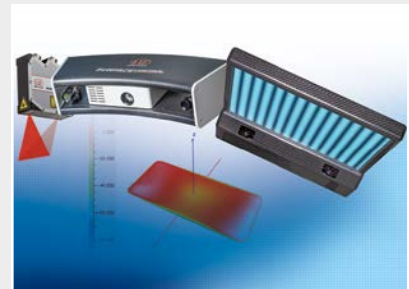

3D measurement technology for dimensional testing and surface inspection