



# More Precision

thermo**IMAGER** TIM // Compact thermal imaging cameras





### thermoIMAGER TIM G7

Thermal imaging camera with line scan feature for the glass industry

- Line scan feature via license-free TIMConnect analysis software
- Compact size of 46 x 56 x 90 mm
- Frame rate up to 125 Hz
- Robust against ambient temperatures up to 70 °C without requiring additional cooling, up to 315 °C with cooling jacket
- Optional integration of a reference pyrometer for glass with a reflection coating
- Compact design (46 x 56 x 90 mm) with USB interface
- Lightweight (320 g incl. lens)
- Exchangeable lenses & industrial accessories
- Software TIMConnect included
- Software Developer Kit and LabVIEW examples included

### Software

- Line scan feature
- Display of the thermal image in real time (80 Hz) with recording function (video, snapshot)
- Complete set up of parameters and remote control of the camera
- Detailed analysis of fast, thermodynamic processes
- Output of analog temperature or alarm values via the process interface
- Digital communication via RS232 or DLL for software integration

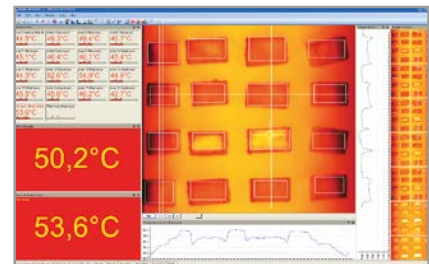

Exact temperature measurement on moving glass surfaces due to line scan feature

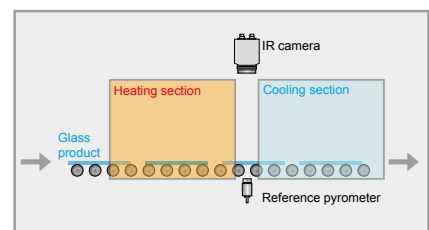

Line scan camera feature measures the temperature distribution between the heating zone and the cooling zone e.g. when toughened or tempered safety glass is heat-treated.

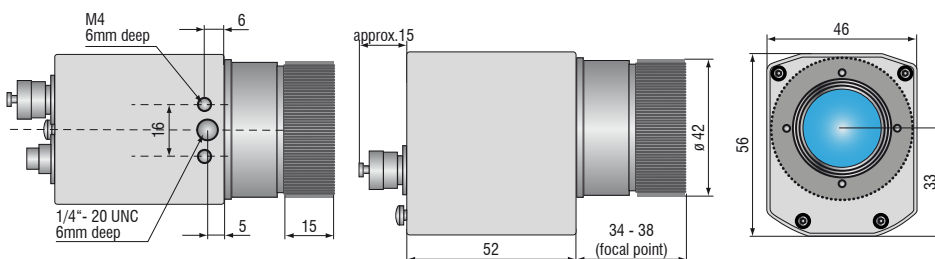

Model	TIM G7	TIM G7 VGA
Optical resolution	382 x 288 pixels	640 x 480 pixels
Temperature ranges	200 °C to 1500 °C	
Sighting range	0 °C to 250 °C (no measurement)	
Spectral range	7.9 μm	
Frame rate	switchable 80 Hz or 27 Hz	32 Hz / 125 Hz in the subframe mode (640x120 pixels)
System accuracy	±2 °C or ±2 %, whichever is greater	
Lenses	13° x 10° FOV / f = 41 mm <sup>1)</sup> or 29° x 22° FOV / f = 18.7 mm <sup>1)</sup> or 53° x 40° FOV / f = 10.5 mm <sup>1)</sup> or 80° x 56° FOV / f = 7.7 mm <sup>1)</sup>	15° x 11° FOV / f = 42 mm <sup>1)</sup> or 33° x 25° FOV / f = 18.7 mm <sup>1)</sup> or 60° x 45° FOV / f = 10.5 mm <sup>1)</sup> or 90° x 64° FOV / f = 7.7 mm <sup>1)</sup>
Thermal sensitivity (NETD)	130 mK	
Detector	FPA, uncooled (25 μm x 25 μm)	FPA, uncooled (17 μm x 17 μm)
Outputs/digital	USB 2.0 / optional GigE	
Standard process interface (PIF)	0-10 V input, digital input (max. 24 V), 0-10 V output	
Industry process interface (PIF)	2x 0-10 V inputs, digital input (max. 24 V), 3x 0(4)-20 mA outputs, 3x relays (0-30 V/ 400 mA), fail-safe relay	
Cable length (USB)	1 m (standard), 5 m, 10 m 5 m and 10 m also as high temperature USB cable (180 °C)	
Power supply	USB powered	
Tripod mount	¼-20 UNC	
Protection class	IP67	
Ambient temperature range	0 °C to 70 °C	0 °C up to 50 °C
Storage temperature	-40 °C to 85 °C	-40 °C to 70 °C
Relative humidity	20 to 80 %, non-condensing	
Vibration	IEC 60068-2-6 (sinus-shaped) / IEC 60068-2-64 (broadband noise)	
Shock	IEC 60068-2-27 (25 g and 50 g)	
Housing (size)	46 mm x 56 mm x 90 mm	
Weight	320 g, incl. lens	

PC requirements: minimum 1.5 GHz, 1 GB RAM, Windows XP SP 2 or Windows 7

<sup>1)</sup> Please note: measurement accuracy can be out of specification with distances below 200 mm

## Scope of supply

### TIM G7

- TIM process camera  
incl. a selectable lens
- Instruction Manual
- USB cable 1 m
- Software for real-time processing  
and analyzing thermal images
- Tripod mount
- PIF cable incl. terminal block (1 m)
- Transport case

### thermoIMAGER TIM NetPC / NetPCQ PC solution for thermoIMAGER TIM applications

TIM NetPC is a professional, embedded industrial PC solution with passive cooling (fanless) for thermoIMAGER applications and is suitable for top hat rail mounting. The NetPC and the TIM camera can be operated in combination as stand-alone system. Remote maintenance via Ethernet is possible. Data provided by the TIM camera can be stored directly on the NetPC where customer-specific software can also be installed. A recovery-stick is included in the scope of delivery.

- Supports all thermoIMAGER TIM models
- Supports 120 Hz (TIM 160), up to 80 Hz (TIM 4x0), up to 32 Hz (TIM 640) frame rates
- Including TIMConnect software
- Monitor via VGA (analog)
- Integrated watchdog feature
- Optional: up to 20 m USB cable, high temperature USB cable, extendable up to 100 m Ethernet cable



thermoIMAGER TIM NetPC

Model	TIM NetPC	TIM NetPCQ
Ambient temperature range	0 °C to 50 °C	
Storage temperature	-20 °C to 60 °C	
Relative humidity	10 to 95 %, non-condensing	
Dimensions	165 x 65 x 130 mm (W x H x D)	
Material (housing)	Anodized aluminum	
Weight	1000 g	
Vibration	IEC-2-6: 3 G, 11 - 200 Hz, each axis	
Shock	IEC-2-27: 50 G, 11 ms, each axis	
Operating system	Windows 7 embedded	
Power supply	12 - 24 V DC	
Power consumption	approx. 9.5 W without TIM [0.76 A with 12 V]	
Cooling	passive cooling (fanless)	
Processor	Intel® Atom™ 2600 @ 2x1.6 GHz Dual	Intel® Atom™ J1900 @ 4x2.4 GHz
Hard drive	integrated 64 GB SSD	
RAM	2 GB DDR3 RAM 800 MHz	
Ports	1 Gbit/s (GigE), 2 x RS 232, 4 x USB 2.0, VGA	1 GigE, 2 x RS232 / 485, 3 x USB 2.0, 1 x USB 3.0, VGA
Additional functions	1x status LED	

## thermoIMAGER TIM NetBox Miniature PC for thermoIMAGER TIM series

- Can be integrated into CoolingJacket Advanced Extended
- Miniature PC for TIM 160/ 4x0 standalone mode for cable extension
- Supports 120 Hz (TIM 160 up to 70 Hz (TIM 4x0) frame rate, 32 Hz (TIM 640)
- Integrated hardware and software watchdog
- Optional: up to 20 m USB cable, high temperature USB cable, extendable up to 100 m Ethernet cable (PoE)



thermoIMAGER TIM NetBox

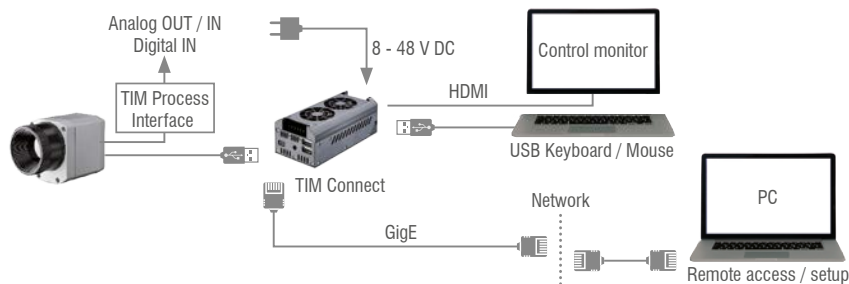

Model	TIM NetBox
Operating temperature	0 °C up to 50 °C
Storage temperature	-20 °C to 75 °C
Relative humidity	10 to 95 %, non-condensing
Material (housing)	Anodized aluminum
Dimensions	113 x 57 x 47 mm
Weight	385 g
Vibration	IEC 60068-2-6 (sinus-shaped) / IEC 60068-2-64 (broadband noise)
Shock	IEC 60068-2-27 (25 g and 50 g)
Operating system	Windows 7 Professional
Power supply	8 ... 48 VDC or Power over Ethernet (PoE/ 1000BASE-T)
Power consumption	7.5 W (+ additional 2.5 W for TIM camera)
Cooling	Active via two integrated fans
Board	COM Express® mini embedded board
Processor	Intel® E3845 Quad Core, 1.91 GHz
Hard drive	16 GB SSD
RAM	2 GB (DDR2, 533MHz)
Ports	2x USB 2.0, 1x USB 3.0, 1x Mini-USB 2.0, Micro-HDMI, Ethernet (Gigabit Ethernet)
Extensions	micro SDHC / SDXC card
Additional functions	4x status LEDs



## TIMConnect SOFTWARE FEATURES

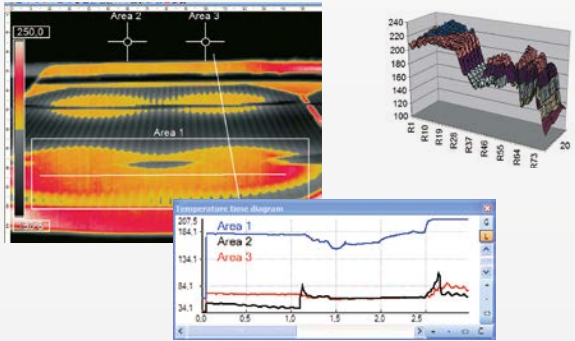

### Comprehensive IR camera software

- License-free analysis software and complete SDK included
- Intuitive user interface
- Camera remote control via software
- Displays several camera images in different windows
- Compatible with Windows 7, 8 and 10 and Linux (Ubuntu)
- Data output via PIF hardware interface using up to 3 analog channels



Windows 7

Windows 10



### Video recording and snapshot feature (IR or BI-SPECTRAL)

- Recording of video sequences and individual images for later analysis or documentation
- Adjustable frame rate to reduce data volume
- Display of snapshot process for direct analysis

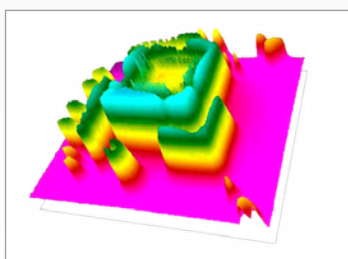
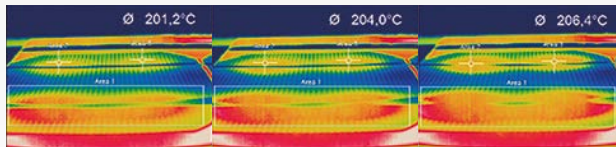

### Online and offline data analysis

- Real-time temperature information (°C or °F) in main window, as digital display or graphic display
- Detailed analysis using measuring fields, automatic hotspot/coldspot search
- Logical linking of temperature information
- Slow-motion replay without connected camera
- Various color palettes to highlight thermal contrasts

### Temperature data analysis and documentation

- Triggered data collection
- Radiometric video sequences (\*.ravi) and snapshots (\*.tiff)
- Thermal images as \*.tiff or text files \*.csv, \*.dat incl. complete temperature information
- Data transfer in real time to other software programs via DLL or COM port interfaces

TIM 160 / 200		Focal length [mm]	Angle	Minimum measurement distance*	Distance to measurement object [m]											
160 x 120 px					0.02	0.1	0.2	0.3	0.5	1	2	4	6	10	30	100
23° Standard lens	10	23° 17° 29° 2.48 mrad	0.2 m	HFOV [m]	0.012	0.043	0.08	0.12	0.21	0.41	0.81	1.62	2.44	4.1	12.2	40.6
				VFOV [m]	0.009	0.032	0.06	0.09	0.15	0.30	0.60	1.21	1.81	3.0	9.0	30.1
				DFOV [m]	0.015	0.054	0.10	0.16	0.26	0.51	1.01	2.02	3.03	5.1	15.2	50.5
				IFOV [mm]	0.1	0.3	0.5	0.8	1.3	2.5	5.0	9.9	14.9	24.8	74.4	248.0
6° Telephoto lens	35.5	6° 5° 8° 0.70 mrad	0.5 m	HFOV [m]					0.06	0.11	0.23	0.45	0.68	1.1	3.4	11.3
				VFOV [m]					0.04	0.09	0.17	0.34	0.51	0.8	2.5	8.5
				DFOV [m]					0.07	0.14	0.28	0.57	0.85	1.4	4.2	14.2
				IFOV [mm]					0.4	0.7	1.4	2.8	4.2	7.0	21.1	70.4
48° Wide angle lens	5.7	41° 31° 51° 4.39 mrad	0.2 m	HFOV [m]	0.022	0.082	0.16	0.23	0.38	0.76	1.51	3.00	4.50	7.5	22.5	74.9
				VFOV [m]	0.016	0.059	0.11	0.17	0.28	0.55	1.10	2.19	3.28	5.5	16.4	54.5
				DFOV [m]	0.027	0.101	0.19	0.29	0.47	0.94	1.86	3.72	5.57	9.3	27.8	92.7
				IFOV [mm]	0.1	0.4	0.9	1.3	2.2	4.4	8.8	17.5	26.3	43.9	131.6	438.6
72° Wide angle lens	3.3	72° 52° 89° 7.51 mrad	0.2 m	HFOV [m]	0.039	0.152	0.29	0.43	0.72	1.42	2.84	5.66	8.49	14.1	42.4	141.4
				VFOV [m]	0.027	0.106	0.20	0.30	0.50	0.99	1.98	3.95	5.92	9.9	29.6	98.6
				DFOV [m]	0.048	0.186	0.36	0.53	0.87	1.74	3.46	6.91	10.35	17.2	51.7	172.3
				IFOV [mm]	0.2	0.8	1.5	2.3	3.8	7.5	15.0	30.0	45.0	75.1	225.2	750.8

TIM 400 / 450 / G7		Focal length [mm]	Angle	Minimum measurement distance*	Distance to measurement object [m]											
382 x 288 px					0.02	0.1	0.2	0.3	0.5	1	2	4	6	10	30	100
29° Standard lens	18.7	29° 22° 37° 1.34 mrad	0.2 m	HFOV [m]		0.060	0.11	0.16	0.27	0.53	1.0	2.1	3.1	5.2	15.6	52.1
				VFOV [m]		0.045	0.08	0.12	0.20	0.40	0.78	1.6	2.3	3.9	11.7	39.0
				DFOV [m]		0.074	0.14	0.20	0.33	0.66	1.3	2.6	3.9	6.5	19.5	65.1
				IFOV [mm]		0.1	0.3	0.4	0.7	1.3	2.7	5.4	8.0	13.4	40.1	133.7
13° Telephoto lens (except for G7)	41	13° 10° 17° 0.61 mrad	0.5 m	HFOV [m]					0.12	0.23	0.47	0.94	1.40	2.3	7.0	23.4
				VFOV [m]					0.09	0.17	0.35	0.70	1.05	1.7	5.2	17.5
				DFOV [m]					0.15	0.29	0.58	1.17	1.75	2.9	8.8	29.2
				IFOV [mm]					0.3	0.6	1.2	2.5	3.7	6.1	18.4	61.2
53° Wide angle lens	10.5	53° 40° 66° 2.38 mrad	0.2 m	HFOV [m]		0.11	0.21	0.31	0.51	1.0	2.0	4.0	6.0	9.9	29.7	99.0
				VFOV [m]		0.08	0.15	0.23	0.37	0.73	1.4	2.9	4.3	7.2	21.6	71.9
				DFOV [m]		0.14	0.26	0.38	0.63	1.2	2.5	4.9	7.4	12.2	36.7	122.3
				IFOV [mm]		0.2	0.5	0.7	1.2	2.4	4.8	9.5	14.3	23.8	71.5	238.4
80° Wide angle lens	7.7	80° 56° 97° 3.25 mrad	0.2 m	HFOV [m]		0.182	0.35	0.84	0.84	1.65	3.29	6.55	9.82	16.4	49.0	163.4
				VFOV [m]		0.119	0.23	0.55	0.54	1.08	2.14	4.28	6.41	10.7	32.0	106.6
				DFOV [m]		0.218	0.41	1.00	1.00	1.97	3.92	7.83	11.73	19.5	58.5	195.1
				IFOV [mm]		0.3	0.7	1.6	1.6	3.3	6.5	13.0	19.5	32.5	97.4	324.7

TIM 640 640 x 480 px	Focal length [mm]	Angle	Minimum measurement distance*	Distance to measurement object [m]											
					0.1	0.2	0.3	0.5	1	2	4	6	10	30	100
33° Standard lens	18.7	33° 25° 41° 0.91 mrad	0.2 m	HFOV [m]	0.068	0.13	0.19	0.31	0.60	1.20	2.38	3.57	5.9	17.8	59.3
				VFOV [m]	0.051	0.09	0.14	0.23	0.45	0.89	1.77	2.65	4.4	13.2	44.2
				DFOV [m]	0.085	0.16	0.23	0.38	0.75	1.49	2.97	4.45	7.4	22.2	74.0
				IFOV [mm]	0.1	0.2	0.3	0.5	0.9	1.8	3.6	5.5	9.1	27.3	90.9
15° Telephoto lens	41.5	15° 11° 19° 0.41 mrad	0.5 m	HFOV [m]				0.13	0.26	0.52	1.05	1.57	2.6	7.8	26.1
				VFOV [m]				0.10	0.20	0.39	0.79	1.18	2.0	5.9	19.6
				DFOV [m]				0.17	0.33	0.66	1.31	1.96	3.3	9.8	32.7
				IFOV [mm]				0.2	0.4	0.8	1.6	2.5	4.1	12.3	41.0
60° Wide angle lens	10.5	60° 45° 75° 1.62 mrad	0.2 m	HFOV [m]	0.128	0.25	0.36	0.59	1.17	2.32	4.63	6.94	11.6	34.6	115.4
				VFOV [m]	0.091	0.18	0.26	0.42	0.83	1.66	3.31	4.96	8.3	24.7	82.4
				DFOV [m]	0.157	0.30	0.44	0.72	1.43	2.85	5.69	8.52	14.2	42.6	141.8
				IFOV [mm]	0.2	0.3	0.5	0.8	1.6	3.2	6.5	9.7	16.2	48.6	161.9
90° Super wide angle lens	7.7	90° 64° 111° 2.21 mrad	0.2 m	HFOV [m]	0.220	0.43	0.63	1.03	2.03	4.04	8.06	12.07	20.1	60.3	200.8
				VFOV [m]	0.138	0.27	0.39	0.64	1.27	2.53	5.05	7.57	12.6	37.8	125.9
				DFOV [m]	0.260	0.50	0.73	1.21	2.39	4.76	9.50	14.24	23.7	71.1	237.0
				IFOV [mm]	0.2	0.4	0.7	1.1	2.2	4.4	8.8	13.2	22.1	66.2	220.8

FOV = Field of view; HFOV = Horizontal field of view; VFOV = Vertical field of view; DFOV = Diagonal dimension of the total measuring field at the object level; IFOV = Indicated field of view  
Table with examples showing which measuring field sizes and pixel sizes are reached at which distance. Various lenses are available for optimal configuration of the camera.  
Wide angle lenses have radial distortion due to the angle of their aperture. The TIMConnect software has an algorithm which corrects this distortion.

\* Please note: The measurement accuracy of the camera may lie outside of the specifications for distances below the defined minimum measurement distance.

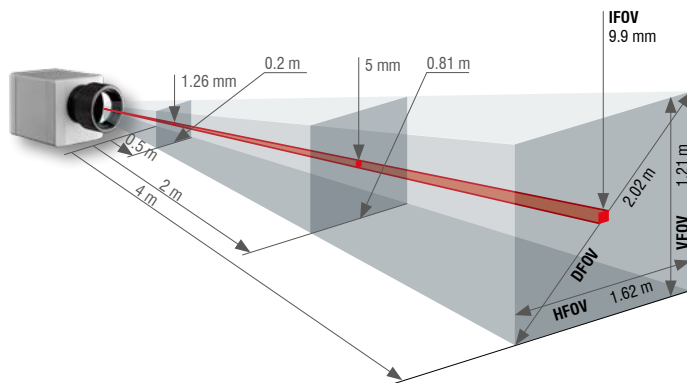

- Standard-, telephoto- and wide angle lenses for adaptation to different applications
- High quality germanium lenses and special anti-reflective coating for excellent optics
- Factory-calibrated lenses for easy exchange of optical system without recalibration

Measuring field sizes can be calculated online at [www.micro-epsilon.com/optikkalkulator](http://www.micro-epsilon.com/optikkalkulator).



TIM M1 / TIM M05 <sup>1)</sup>	Focal length [mm]	Angle	Minimum measurement distance*	Distance to measurement object [m]											
					0.1	0.2	0.3	0.5	1	2	4	6	10	30	100
382 x 288 px	16	20° 15° 25° 0.94 mrad	0.2 m	HFOV [m]		0.07	0.11	0.18	0.36	0.72	1.43	2.15	3.6	10.7	35.8
				VFOV [m]		0.05	0.08	0.14	0.27	0.54	1.08	1.62	2.7	8.1	27.0
				DFOV [m]		0.09	0.13	0.22	0.45	0.90	1.79	2.69	4.5	13.5	44.9
				IFOV [mm]		0.2	0.3	0.5	0.9	1.9	3.8	5.6	9.4	28.1	93.8
f=25 mm standard lens	25	13° 10° 16° 0.60 mrad	0.5 m	HFOV [m]	0.023	0.05	0.07	0.11	0.23	0.46	0.92	1.38	2.3	6.9	22.9
				VFOV [m]	0.017	0.03	0.05	0.09	0.17	0.35	0.69	1.04	1.7	5.2	17.3
				DFOV [m]	0.029	0.06	0.09	0.14	0.29	0.57	1.15	1.72	2.9	8.6	28.7
				IFOV [mm]	0.1	0.1	0.2	0.3	0.6	1.2	2.4	3.6	6.0	18.0	60.0
f=50 mm telephoto lens	50	7° 5° 8° 0.30 mrad	1.5 m	HFOV [m]				0.06	0.11	0.23	0.46	0.69	1.1	3.4	11.5
				VFOV [m]				0.04	0.09	0.17	0.35	0.52	0.9	2.6	8.6
				DFOV [m]				0.07	0.14	0.29	0.57	0.86	1.4	4.3	14.4
				IFOV [mm]				0.2	0.3	0.6	1.2	1.8	3.0	9.0	30.0
f=75 mm Super telephoto lens	75	4° 3° 5° 0.20 mrad	2.0 m	HFOV [m]					0.08	0.15	0.31	0.46	0.8	2.3	7.6
				VFOV [m]					0.06	0.12	0.23	0.35	0.6	1.7	5.8
				DFOV [m]					0.10	0.19	0.38	0.57	1.0	2.9	9.6
				IFOV [mm]					0.2	0.4	0.8	1.2	2.0	6.0	20.0

<sup>1)</sup> TIM M05 only available with OF25 lens | Please note: the camera provides 382 x 288 px in the 80 Hz mode

TIM M1 / M05 with VGA <sup>1)</sup> Resolution	Focal length [mm]	Angle	Minimum measurement distance*	Distance to measurement object [m]											
					0.1	0.2	0.3	0.5	1	2	4	6	10	30	100
764 x 480 px	16	39° 25° 46° 0.94 mrad	0.2 m	HFOV [m]		0.14	0.21	0.36	0.72	1.43	2.87	4.30	7.2	21.5	71.6
				VFOV [m]		0.09	0.14	0.23	0.45	0.90	1.80	2.70	4.5	13.5	45.0
				DFOV [m]		0.17	0.25	0.42	0.85	1.69	3.38	5.08	8.5	25.4	84.6
				IFOV [mm]		0.2	0.3	0.5	0.9	1.9	3.8	5.6	9.4	28.1	93.8
f=25 mm standard lens	25	26° 16° 30° 0.60 mrad	0.5 m	HFOV [m]	0.046	0.09	0.14	0.23	0.46	0.92	1.83	2.75	4.6	13.8	45.8
				VFOV [m]	0.029	0.06	0.09	0.14	0.29	0.58	1.15	1.73	2.9	8.6	28.8
				DFOV [m]	0.054	0.11	0.16	0.27	0.54	1.08	2.17	3.25	5.4	16.2	54.1
				IFOV [mm]	0.1	0.1	0.2	0.3	0.6	1.2	2.4	3.6	6.0	18.0	60.0
f=50 mm telephoto lens	50	13° 8° 15° 0.30 mrad	1.5 m	HFOV [m]				0.11	0.23	0.46	0.92	1.38	2.3	6.9	22.9
				VFOV [m]				0.07	0.14	0.29	0.58	0.86	1.4	4.3	14.4
				DFOV [m]				0.14	0.27	0.54	1.08	1.62	2.7	8.1	27.1
				IFOV [mm]				0.2	0.3	0.6	1.2	1.8	3.0	9.0	30.0
f=75 mm Super telephoto lens	75	9° 5° 10° 0.20 mrad	2.0 m	HFOV [m]					0.15	0.31	0.61	0.92	1.5	4.6	15.3
				VFOV [m]					0.10	0.19	0.38	0.58	1.0	2.9	9.6
				DFOV [m]					0.18	0.36	0.72	1.08	1.8	5.4	18.0
				IFOV [mm]					0.2	0.4	0.8	1.2	2.0	6.0	20.0

<sup>1)</sup> TIM M05 is only available with OF25 lens | Please note: the camera provides 764 x 480 px in the 32 Hz mode

## High performance sensors made by Micro-Epsilon



Sensors and systems for displacement and position



Sensors and measurement devices for non-contact temperature measurement



2D/3D profile sensors (laser scanner)



Optical micrometers, fiber optic sensors and fiber optics



Color recognition sensors, LED analyzers and color online spectrometer



Measurement and inspection systems