



# More Precision

**thermoMETER** // Non-contact infrared temperature sensors





### thermoMETER CTLaserM3

Non-contact IR temperature sensor with laser sighting for metals and composite material processing from 50°C

- Measuring range 50°C to 1800°C
- 2.3 $\mu$ m measuring wavelength for exact measurement in difficult emissivity conditions

- Response time of 1ms
- Double laser marks exact spot size from 0.5mm
- Optical resolution 300:1, 100:1 and 60:1 with selectable focus
- Up to 85°C ambient temperature without cooling, automatic laser switch-off at 50°C, up to 315°C with water cooled housing

#### Optical specifications thermoMETER CTLaserM3

□ = smallest spot size / focal point (mm)

##### Standard Focus

3LSF	60:1	20	19.8	19.5	19.3	19.1	18.8	18.6	18.5	18.3	21.8	27	32.2	40.9	56.6
3HSF	100:1	20	18.8	17.5	16.3	15.1	13.9	12.6	11.8	11	13.8	18	22.3	29.3	42
3 H1/H2/H3 SF300	300:1	12	10.9	9.7	8.6	7.5	6.3	5.2	4.5	3.7	5.1	7.3	9.4	13	19.4
distance in mm		0	150	300	450	600	750	900	1000	1100	1200	1350	1500	1750	2200

##### Close Focus

3LCF1	60:1	20	11.2	1.4	10.2	17.8	30.4	42.9	55.5	80.7	105.9	131.1	156.2	181.4	
3HCF1	100:1	20	11	0.9	9.5	16.9	29.2	41.5	53.8	78.4	102.9	127.5	152.1	176.7	
distance in mm		0	40	85	120	150	200	250	300	400	500	600	700	800	

##### Close Focus

3LCF2	60:1	20	14.2	8.3	2.5	10	17.5	25	40	55	70	85	100		
3HCF2	100:1	20	13.8	7.7	1.5	8.7	15.8	23	37.3	51.7	66	80.3	94.7		
3 H1/H2/H3 CF2	300:1	12	8.2	4.3	0.5	4.7	8.8	13	21.3	29.7	38	46.3	54.7		
3LCF3	60:1	20	15.8	11.7	7.5	3.3	9.1	15	26.6	38.3	49.9	61.6	73.2		
3HCF3	100:1	20	15.5	11	6.5	2	7.5	13	24	35	46	57	68		
3 H1/H2/H3 CF3	300:1	12	9.2	6.4	3.5	0.7	3.9	7	13.4	19.8	26.1	32.4	38.8		
distance in mm		0	50	100	150	200	250	300	400	500	600	700	800		

##### Close Focus

3LCF4	60:1	20	18.6	17.2	15.8	14.4	13.1	11.7	10.3	8.9	7.5	10.6	16.7	22.8	28.9
3HCF4	100:1	20	18.3	16.6	14.8	13.1	11.4	9.7	7.9	6.2	4.5	7.2	12.7	18.1	23.6
3 H1/H2/H3 CF4	300:1	12	10.8	9.7	8.5	7.3	6.2	5	3.8	2.7	1.5	3	6	9	12
distance in mm		0	50	100	150	200	250	300	350	400	450	500	600	700	800

##### Far Field

3 H1/H2/H3 FF	300:1	12	12	12	12	12	12	12	12	12	12	14.7	21.3	28	33
distance in mm		0	450	900	1350	1800	2250	2700	3000	3600	4000	5000	6000	6750	

Model	CTLM- 3LSF60-C3	CTLM- 3HSF100-C3	CTLM- 3H1SF300-C3	CTLM- 3H2SF300-C3	CTLM- 3H3SF300-C3
Optical resolution	60:1	100:1	300:1		
Temperature range <sup>1,2</sup>	50 to 400°C	100 to 600°C	150 to 1000°C	200 to 1500°C	250 to 1800°C
Spectral range	2.3µm				
System accuracy <sup>3</sup>	±(0.3% of reading +2°C)				
Repeatability <sup>3</sup>	±(0.1% of reading +1°C)				
Temperature resolution (digital)	0.1°C				
Response time (90% signal) <sup>4</sup>	1ms				
Emissivity/gain <sup>1</sup>	0.100 to 1.100				
Transmissivity/gain <sup>1</sup>	0.100 to 1.100				
Signal processing <sup>1</sup>	peak hold, valley hold, average; extended hold function with threshold and hysteresis				
Certificate of calibration	optional				
Outputs/analog	channel 1	0/4 to 20mA, 0 to 5/10V, thermocouple J, K			
Outputs/analog	optional	relays: 2 x 60VDC/42 VAC <sub>eff</sub> ; 0.4A; electrically isolated			
Alarm output		open collector (24V / 50A)			
Outputs/digital		USB, RS232, RS485, CAN, Profibus DP, Ethernet			
Output impedances	current output	mA max. 500Ω (with 5 - 36VDC)			
	voltage output	mV min. 100kΩ load impedance; thermocouple 20Ω			
Inputs	programmable functional inputs for external emissivity adjustment ambient temperature compensation, trigger (reset of hold functions)				
Cable length	3m (standard), 8m, 15m				
Power supply	8 to 36VDC; max. 160mA				
Laser	class II (635nm), 1mW, ON/OFF via controller or software				
Protection class	IP65 (NEMA-4)				
Ambient temperature	sensor: -20°C to 85°C (50°C if Laser ON); controller: 0°C to 85°C				
Storage temperature	sensor: -40°C to 85°C controller: -40°C to 85°C				
Relative humidity	10 to 95%, non-condensing				
Vibration	sensor	IEC 68-2-6: 3 G, 11-200Hz, any axis			
Shock	sensor	IEC 68-2-27: 50 G, 11ms, any axis			
Weight	sensor: 600g; controller: 420g				

<sup>1</sup> adjustable via controller or software

<sup>2</sup> target temperature > sensor temperature + 25°C

<sup>3</sup> ε=1, response time 1s; ambient temperature: 23±5°C

<sup>4</sup> with dynamic adaption at low signal levels

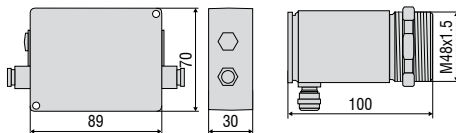

#### Product identification

CTLM -	3	L	SF60-	C3
Cable length [3m (standard) / 8m / 15m]				
Focus [SF60/100 / CF1 / CF2 / CF3 / CF4]				
Temperature range [L / H]				
Spectral range [2.3µm]				
thermoMETER CTLaserM				

#### Accessories page 20 - 21

- Mounting bracket
- Air purge collar
- Rail mount adapter for controller
- Water cooled housing
- Interface kit
- Certificate of calibration



**LASER LIGHT**  
DO NOT STARE INTO BEAM  
CLASS 2 LASER  
DIN EN 60825-1:2007  
1mW / 630-650nm

**CTLaser / CTLaserFAST / CTLaserGLASS / CTLaserM1/M2/M3/M5 / CTLaserCOMBUSTION**

**Controller**

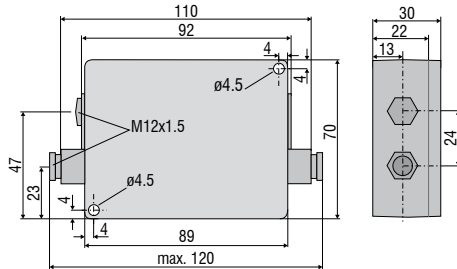

**Sensor**

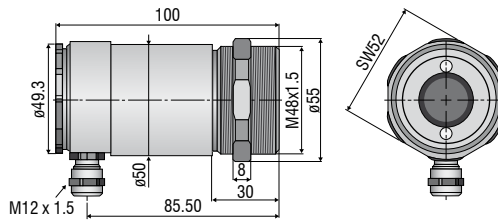

**CTratioM1**

**Controller**

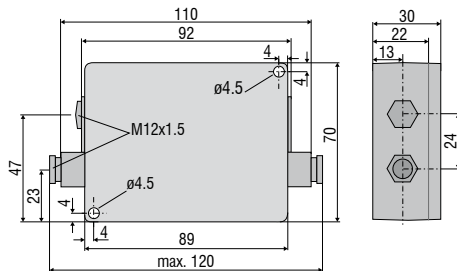

**Sensor**

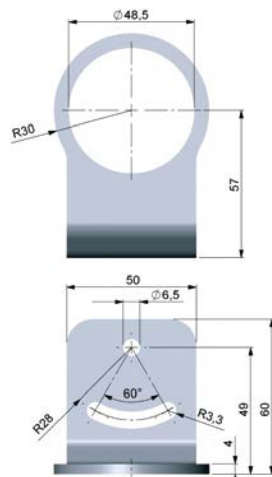
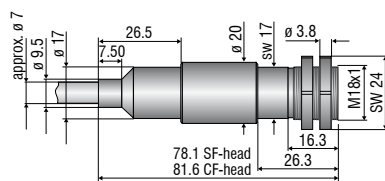

TM-FB-CTL Mounting bracket (fixed); included in CTL scope of supply

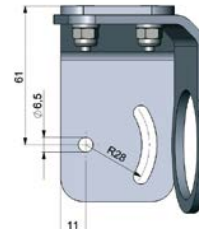
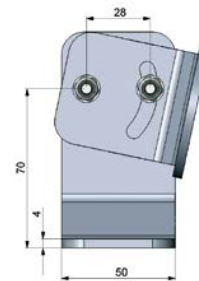

TM-AB-CTL Mounting bracket (adjustable)



TM-W-CTL Water cooled housing and air purge collar TM-AP-CTL, mounted on adjustable mounting bracket TM-AB-CTL

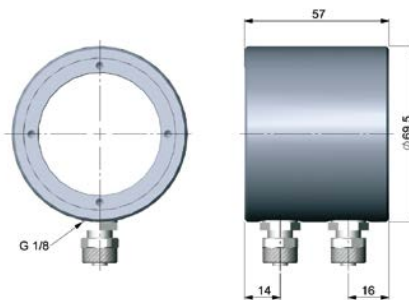

TM-W-CTL Water cooled housing

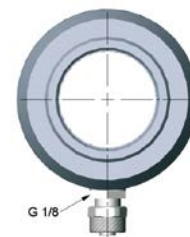

TM-AP-CTL Air purge collar





Mechanical accessories		
Art. No.	Model	
2970238	TM-AB-CTL	Mounting bracket, adjustable, stainless steel
2970239	TM-AP-CTL	Air purge collar, stainless steel
2970240	TM-W-CTL	Water cooled housing, stainless steel, for ambient temperatures up to 175°C
2970241	TM-RAIL-CTL	Rail mount adapter for CTLaser controller
2970242	TM-COV-CTL	Closed cover for controller
2970243	TM-MN-CTL	Mounting nut, stainless steel (spare)
2970244	TM-FB-CTL	Mounting bracket, fixed, stainless steel (spare)
2970298	TM-A20UN-CTL	Screw adapter M48x1.5 on 20UN-2A screw including mounting nut

High temperature accessories		
Art. No.	Model	
2970366	TM-J-CTL	Cooling jacket (length 228mm, ø89mm) (conversion kit TM-CONK-CTL is required)
2970374	TM-CONK-CTL	Conversion kit for CTL on axial cable exit, for integration in cooling jacket
2970368	TM-JAB-CTL	Adjustable mounting bracket for cooling jacket
2970369	TM-MF-CTL	Mounting flange M48x1.5 for TM-PF-CTL
2970370	TM-AST300-CTL	Reflection protection tube M48x1.5, 300mm length
2970371	TM-PA-CTL	Pipe adapter M48x1.5
2970372	TM-RM-CTL	Furnace wall mount accessory for CTL (TM-MF-CTL, TM-AST300-CTL and TM-PA-CTL)
2970412	TM-PF-CTL	Pipe flange M48x1.5 for directly mounting a CTL sensor
2970487	TM-CJA-CTL	Cooling Jacket Advanced - universal cooling jacket for CSLaser, CTLaser and CTVideo / CSVideo up to 315°C

Calibration		
Art. No.	Model	
2970253	TM-CERT-CTL	Certificate of calibration
2970324	TM-HTCERT-CTL	Certificate of calibration for CTLaser M1-/M2-/M3-/M5-/G-sensors

Interfaces		
Art. No.	Model	
2970245	TM-USBK-CTL	USB interface, computer cable, CompactConnect software second cable gland for controller
2970246	TM-RS232K-CTL	RS232 interface, computer cable, CompactConnect software, second cable gland for controller
2970338	TM-RS485USBK-CTL	RS485-USB-adapter, incl. PC cable, CompactConnect software and CTmulti, second cable gland for use with interface board TM-RS485B-CTL
2970248	TM-RS485B-CTL	RS485 interface board incl. second cable gland
2970249	TM-CANK-CTL	CAN-Bus interface; protocol: CANopen Presets: module address20 (14H), 250kbaud, 0-60°C
2970250	TM-PFBDPK-CTL	Profibus-DPV1 interface with plug-in connection
2970251	TM-ETHNK-CTL	Ethernet-Kit: interface board, external Ethernet adapter, CompactConnect software, second cable gland
2970252	TM-RI-CTL	Relay interface: two electrically isolated relays, 60VDC/ 42VAC <sub>eff</sub> 0.4A

Sensor cables and high temperature cables for CTLaser		
Art. No.	Model	
2970374	TM-CONK-CTL	Connector-Kit for cables with connector
4800254.003	TM-CB3C-CTL	Sensor cable with connector (3m)
4800254.003H	TM-CB3HC-CTL	High-temperature sensor cable (up to 180°C) with connector (3m)
4800254.008	TM-CB8C-CTL	Sensor cable with connector (8m)
4800254.008H	TM-CB8HC-CTL	High-temperature sensor cable (up to 180°C) with connector (8m)
4800254.015	TM-CB15C-CTL	Sensor cable with connector (15m)
4800254.015H	TM-CB15HC-CTL	High-temperature sensor cable (up to 180°C) with connector (15m)



TM-J-CTL Cooling jacket (length 228mm, ø 89mm) with adjustable mounting bracket TM-JAB-CTL; suitable for ambient temperatures up to 180°C

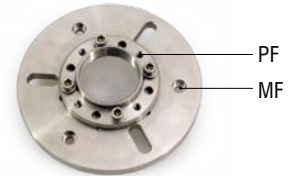

TM-PF-CTL and TM-MF-CTL mounting flange M48x1.5 for directly mounting a CTL sensor



TM-RM-CTL Furnace wall mount accessory for CTLaser / CTratio: TM-MF-CTL, TM-PF-CTL, TM-AST300-CTL and TM-PA-CTL

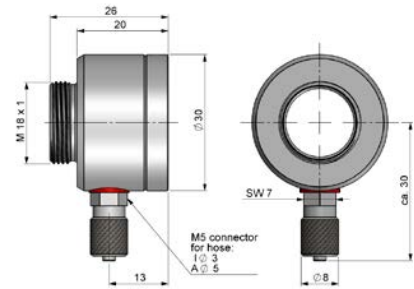

TM-AP-CTR Air purge collar

CTratio		
Art. No.	Model	
2970348	TM-FB-CTR	Mounting bracket, stainless steel, adjustable in one axis
2970395	TM-AP-CTR	Air purge collar, stainless steel
2970373	TM-RM-CTR	Furnace wall mount
2970351	TM-CERT-CTR	Certificate of calibration

## Further IR temperature measurement devices from Micro-Epsilon



**thermoIMAGER TIM**  
Compact USB thermal imaging cameras  
for precise thermography



**thermoMETER CTVideo/CSVideo**  
IR temperature sensors with crosshair laser  
sighting and video output



**thermoMETER Handheld**  
Innovative handheld pyrometer with laser  
sighting for inspection and maintenance