



More Precision

wireSENSOR // Draw-wire displacement sensors





- Miniature design
- Optional IP67 (MPW)
- For fast measurement and harsh environments

Model MP / MPW

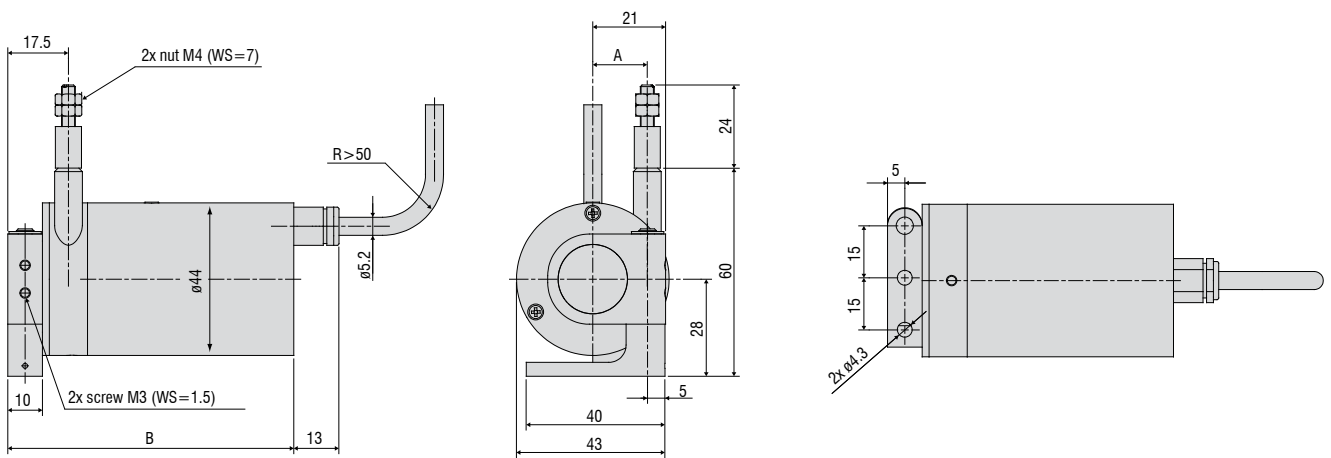

Measuring range (mm)	A (mm)	B (mm)
100 / 300 / 500 / 1000-MP	15.7	82.5
100 / 300 / 500 / 1000-MPW	15.7	86.5

Model	WDS-100 MP(W)	WDS-300 MP(W)	WDS-500 MP(W)	WDS-1000 MP(W)
Output	P			
Measuring range	100mm	300mm	500mm	1000mm
Linearity	±0.1% FSO	-	±0.5mm	±1mm
	±0.25% FSO	-	±0.75mm	-
	±0.5% FSO	±0.5mm	-	-
Resolution	0.15mm	0.2mm	towards infinity	
Sensor element	wire potentiometer		hybrid potentiometer	
Temperature range	-20 °C ... +80 °C			
Material	housing	aluminum		
	draw-wire	stainless steel (ø 0.45mm)		
Wire mounting	thread M4			
Sensor mounting	swivel flange in two axes 180° / 360°			
Wire acceleration	approx. 30g			
Wire retraction force (min)	7N	7N	6.5N	5N
Wire extension force (max)	8.5N	8.5N	8.5N	8N
Protection class	series MP	IP65		
	series MPW	IP67		
Vibration	20g, 20Hz - 2kHz			
Mechanical shock	50g, 10ms			
Electrical connection	integrated cable, axial, 3-leads, 1m			
Weight	approx. 270g			

FSO = Full Scale Output

Specifications for analog outputs on page 51.

Article description

WDS -	100 -	MP -	C -	P
				Output option: P: potentiometer
				Connection: C: integrated cable, axial, 1m
				Model MP / MPW (IP67)
				Measuring range in mm

Accessories:

WE-xxx-M4	Wire extension with M4-wire connection, x=length
WE-xxx-Clip	Wire extension with eyelet, x=length
TR1-WDS	Pulley wheel, adjustable
TR3-WDS	Pulley wheel, fixed
GK1-WDS	Attachment head for M4
MH1-WDS	Magnetic holder for wire mounting
MH2-WDS	Magnetic holder for sensor mounting
MT-60-WDS	Mounting clamp for WDS-P60
FC8	Female connector for WDS, 8-pin
FC8/90	Female connector 90° for WDS
PC 3/8-WDS	Sensor cable, length 3m
PS 2020	(Power Supply 24 V / 2,5 A, Input 100 - 240 VAC, output 24 VDC / 2.5 A, for snap in mounting on DIN 50022 rail)
WDS-MP60	Mounting plate for P60 sensors



Mounting plate WDS-MP60

Installation information:



Wire attachment: The free return of the measurement wire is not permissible and it is essential that this is avoided during installation.

Wire exit angle:

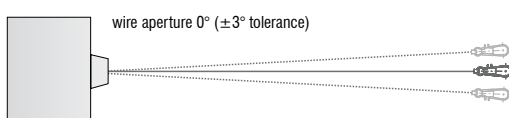
When mounting a draw-wire displacement sensor, a straight wire exit ($\pm 3^\circ$ tolerance) must be taken into account. If this tolerance is exceeded, increased material wear on the wire and at the wire aperture must be expected.

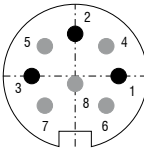
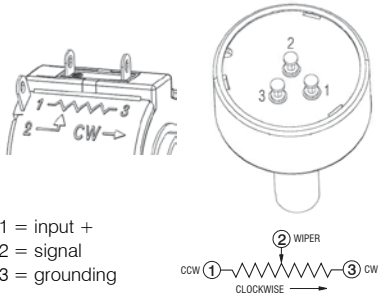

Output	Plug M16 -SA / -SR	Integrated cable -CA / -CR	Open contacts
--------	-----------------------	-------------------------------	---------------

Potentiometric output (P)				
Supply voltage	max. 32VDC at 1kOhm / 1 Wmax	 <p>sensor side</p>	1 = input + 2 = grounding 3 = signal	white = input + brown = grounding green = signal
Resistance	1kOhm ±10% (potentiometer)			
Temperature coefficient	±0.0025% FSO/°C			
				 <p>1 = input + 2 = signal 3 = grounding</p> 

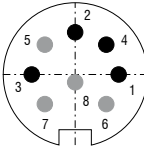
Voltage output (U)				
Supply voltage	14 ... 27VDC (non stabilized)	 <p>sensor side</p>	1 = supply 2 = grounding 3 = signal 4 = ground	white = supply brown = grounding green = signal yellow = ground
Current consumption	max. 30mA			
Output voltage	0 ... 10VDC Option 0 ... 5 / ±5V			
Load impedance	>5kOhm			
Signal noise	0.5mV _{eff}			
Temperature coefficient	±0.005% FSO/°C			
Electromagnetic compatibility (EMC)	EN 61000-6-4 EN 61000-6-2			
Adjustment ranges (if supported by the model)				
Zero	±20% FSO			
Sensitivity	±20%			

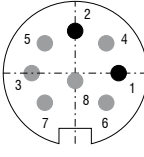
Current Output (I)				
Supply voltage	14 ... 27VDC (non stabilized)	 <p>sensor side</p>	1 = supply 2 = grounding	white = supply brown = grounding
Current consumption	max. 35mA			
Output current	4 ... 20mA			
Load	<600Ohm			
Signal noise	<1,6 μA _{eff}			
Temperature coefficient	±0.01% FSO/°C			
Electromagnetic compatibility (EMC)	EN 61000-6-4 EN 61000-6-2			
Adjustment range (if supported by the model)				
Zero	±18% FSO			
Sensitivity	±15%			

High performance sensors made by Micro-Epsilon



Sensors and systems for displacement and position



Sensors and measurement devices for non-contact temperature measurement



2D/3D profile sensors (laser scanner)



Optical micrometers, fiber optic sensors and fiber optics



Color recognition sensors, LED analysers and color inline spectrometer



Measurement and inspection systems