



More Precision

combiSENSOR // Non-contact thickness measurement of plastics



The sensor for precise thickness measurements of plastics

combiSENSOR



- One-sided thickness measurement in one axis
- Integrated temperature measurement
- Special plug for fast sensor connection
- Thickness measurement based on ϵ_r
- Determination of ϵ_r with known thickness
- Ease of use via web interface

In its sensor housing, the combiSENSOR combines an eddy current displacement sensor and a capacitive displacement sensor. This unique sensor concept enables one-sided thickness measurement of electrically non-conductive materials on metallic objects. Its field of application is the thickness measurement of plastic film or of plastic coating on metal plates. Connected to the sensor via a cable, the controller processes and calculates the signals in order to put them out via interfaces.

Calculation of the two sensor signals provides compensation of mechanical changes such as thermal expansion, deflections or eccentricity in the measurement device. Due to the redundancy of this combined sensor principle, the measured thickness value remains unaffected by any changes in the measurement setup. Due to the high temperature stability, the combiSENSOR provides high measurement accuracy even with fluctuating temperatures.

Possible applications

- Non-contact thickness measurement of plastic films
- Non-contact thickness measurement of coated metals
- Measurement of the applied adhesive
- Lateral profile due to a traversing axis

Measuring principle

The construction of the eddy current measurement coil and the capacitive measurement electrodes is concentric. Both sensors measure against the same spot. The signal of the capacitive displacement sensor is a function of the working distance, the thickness of the insulator (D) and the dielectric constant of the insulator material (ϵ_r). At the same time the eddy current displacement sensor measures the distance to the ground electrode (e.g. metal sheet or metal roller positioned behind the film). The controller outputs both single signals as well as the difference between capacitive sensor and eddy current sensor. Also the dielectric constant can be calculated with known thickness and working distance.

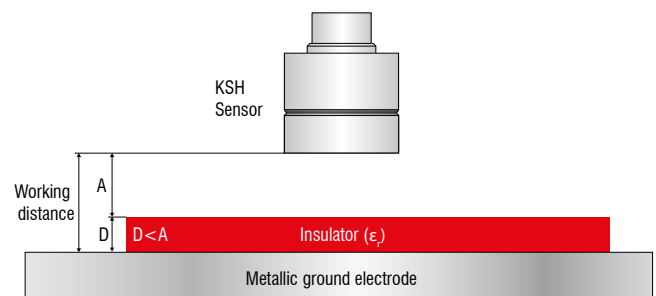

Thickness measurement:

If the dielectric constant ϵ_r and the working distance from the ground electrode are known, the controller calculates the insulator thickness D from the sensor signals.

Calculation of the dielectric constant:

If the thickness of the Insulator D and the working distance from the ground electrode are known, the controller calculates the dielectric constant of the insulator.

Web interface

The web interface for sensor and controller configuration opens via Ethernet.



Controller		KSS6420	KSS6430	KSS6420(01)	KSS6430(01)
Sensor		KSH5(01)		KSH10	
Target thickness (insulator thickness) ¹⁾		40µm ... 3mm		40µm ... 6mm	
Working distance		2mm ... 5mm		4mm ... 10mm	
Min. diameter measurement surface		45mm		65mm	
Resolution ²⁾	static, 100Hz	0.0018% FSO	0.0004% FSO	0.0030% FSO	0.0006% FSO
	dynamic, 3.9kHz	0.0075% FSO	0.0015% FSO	0.0120% FSO	0.0025% FSO
Bandwidth		analog: 1kHz (3dB) ³⁾ , digital: 2.6 ... 3900Sa/s (adjustable)			
Linearity		±0.05% FSO			
Temperature stability	Sensor (+10°C ... +50°C)	±50ppm			
	Controller (+10°C ... +50°C)	±50ppm	±50ppm	±50ppm	±70ppm
Temperature range (operation)		controller: +10°C ... +60°C; sensor: -10°C ... +85°C; sensor cable: -10°C ... +125°C			
Temperature range (storage)		sensor, cable: -10°C ... +100°C, controller: 0°C ... 75°C			
Supply		12 ... 36VDC (5.5W)			
Output	Analog	capacitive, eddy current and differential signal: 0V ... 10V (short circuit proof); internal sensor temperature signal (not scaled)			
	Ethernet	capacitive, eddy current, differential and internal temperature signal: 24Bit			
	EtherCAT	capacitive, eddy current, differential and internal temperature signal: float			
Trigger		TTL, 5V			
Target geometry		Straight surface or min. diameter 200mm ⁴⁾			
Protection class		sensor: IP54, controller: IP40			
Weight		sensor: 80g; controller: 750g			

FSO = Full Scale Output

¹⁾ Insulator thickness below 40µm on request

²⁾ Difference signal of the digital output, measured with offset distance = 50% FSO

³⁾ only valid when sampling rate = 3900Sa/s

⁴⁾ Reference material ground electrode: VA steel (1.4571) or aluminum. Changes of the ground electrode (material or geometry) require a recalibration of sensor and controller by the manufacturer.

Controller

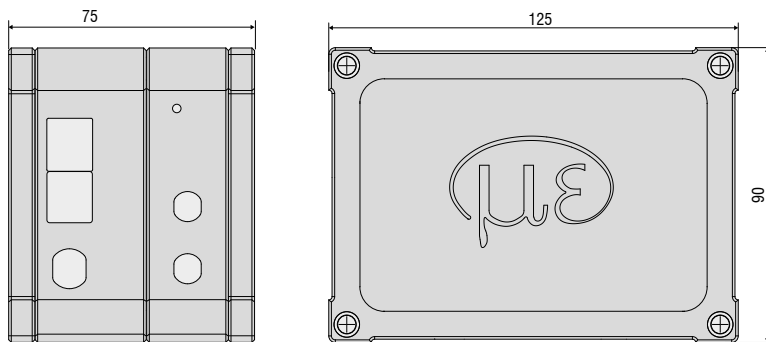

KSH5 sensor

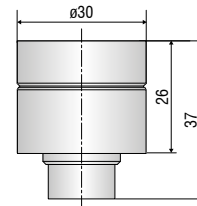

KSH10 sensor

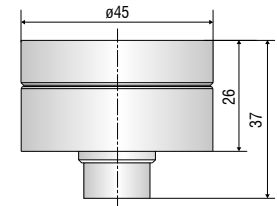

Sensor cable

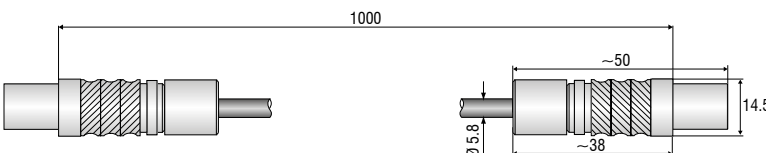

SCAC3/5 connector

Signal output (5-pole plug)

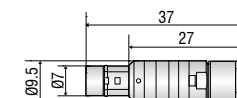

Supply and trigger cable PC6200-3/4

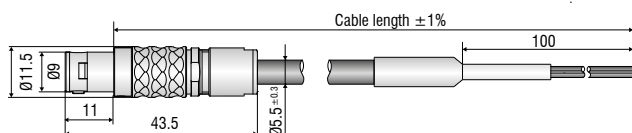

Scope of supply:

- KSH sensor
- Sensor cable 1m
- Controller
- PC6200 3/4 supply and trigger cable (3m)

Accessories:

- SCAC3/5 signal output cable analog (3m)

High performance sensors made by Micro-Epsilon



Sensors and systems for displacement and position



Sensors and measurement devices for non-contact temperature measurement



2D/3D profile sensors (laser scanner)



Optical micrometers, fiber optic sensors and fiber optics



Color recognition sensors, LED analyzers and color online spectrometer



Measurement and inspection systems